

How to Design Programs Teachpacks

Version 9.2.0.5

May 22, 2026

Teaching languages are small subsets of a full programming language. While such restrictions simplify error diagnosis and the construction of tools, they also make it impossible (or at least difficult) to write some interesting programs. To circumvent this restriction, it is possible to import teachpacks into programs written in a teaching language.

In principle, a teachpack is just a library written in the full language, not the teaching subset. Like any other library, it may export values, functions, etc. In contrast to an ordinary library, however, a teachpack must enforce the contracts of the “lowest” teaching language into which it is imported and signal errors in a way with which students are familiar at that level.

This chapter covers the teachpacks for *How to Design Programs*.

Contents

1	HtDP Teachpacks	3
1.1	Manipulating Images: "image.rkt"	3
1.1.1	Images	3
1.1.2	Modes and Colors	3
1.1.3	Creating Basic Shapes	4
1.1.4	Basic Image Properties	5
1.1.5	Composing Images	6
1.1.6	Manipulating Images	8
1.1.7	Scenes	9
1.1.8	Miscellaneous Image Manipulation and Creation	10
1.2	Simulations and Animations: "world.rkt"	11
1.2.1	Simple Simulations	12
1.2.2	Interactions	13
1.2.3	A First Example	17
1.3	Converting Temperatures: "convert.rkt"	22
1.4	Guessing Numbers: "guess.rkt"	23
1.5	MasterMinding: "master.rkt"	24
1.6	Playing MasterMind: "master-play.rkt"	24
1.7	Simple Drawing: "draw.rkt"	24
1.7.1	Drawing on a Canvas	25
1.7.2	Interactions with Canvas	27
1.8	Hangman: "hangman.rkt"	28
1.9	Playing Hangman: "hangman-play.rkt"	29
1.10	Managing Control Arrows: "arrow.rkt"	29

1.11	Manipulating Simple HTML Documents: "docs.rkt"	31
1.12	Working with Files and Directories: "dir.rkt"	32
1.13	Graphing Functions: "graphing.rkt"	33
1.14	Simple Graphical User Interfaces: "gui.rkt"	34
1.15	An Arrow GUI: "arrow-gui.rkt"	36
1.16	Controlling an Elevator: "elevator.rkt"	37
1.17	Lookup GUI: "lkup-gui.rkt"	38
1.18	Guess GUI: "guess-gui.rkt"	39
1.19	Queens: "show-queen.rkt"	39
1.20	Matrix Functions: "matrix.rkt"	40
1.20.1	Matrix Snip	42
2	HtDP/2e Teachpacks	43
2.1	Batch Input/Output: "batch-io.rkt"	43
2.1.1	IO Functions	43
2.1.2	Web Functions	49
2.1.3	Testing	50
2.2	Image Guide	50
2.2.1	Overlaying, Above, and Beside: A House	51
2.2.2	Rotating and Overlaying: A Rotary Phone Dial	52
2.2.3	Alpha Blending	56
2.2.4	Recursive Image Functions	58
2.2.5	Rotating and Image Centers	62
2.2.6	Image Interoperability	64
2.2.7	The Nitty Gritty of Pixels, Pens, and Lines	64
2.2.8	The Nitty Gritty of Alpha Blending	66

2.3	Images: "image.rkt"	68
2.3.1	Basic Images	68
2.3.2	Polygons	78
2.3.3	Overlaying Images	103
2.3.4	Placing Images & Scenes	115
2.3.5	Rotating, Scaling, Flipping, Cropping, and Framing Images	123
2.3.6	Bitmaps	128
2.3.7	Image Properties	130
2.3.8	Image Predicates	132
2.3.9	Equality Testing of Images	137
2.3.10	Pinholes	138
2.3.11	Exporting Images to Disk	141
2.4	Worlds and the Universe: "universe.rkt"	142
2.4.1	Background	142
2.4.2	Simple Simulations	143
2.4.3	Interactions	144
2.4.4	A First Sample World	157
2.4.5	The World is not Enough	159
2.4.6	The Universe Server	164
2.4.7	A First Sample Universe	171
2.5	Web IO: "web-io.rkt"	180
2.6	iTunes: "itunes.rkt"	181
2.6.1	Data Definitions	181
2.6.2	Exported Functions	182
2.7	Abstraction: "abstraction.rkt"	185

2.7.1	Loops and Comprehensions	185
2.7.2	Pattern Matching	189
2.7.3	Algebraic Data Types	191
2.8	Planet Cute Images	193
2.8.1	Characters	194
2.8.2	Blocks	197
2.8.3	Items	200
2.8.4	Ramps	205
2.8.5	Buildings	207
2.8.6	Shadows	211
2.9	Porting World Programs to Universe	219
2.9.1	The World is Not Enough	219
2.9.2	Porting World Programs	219
2.9.3	Porting Image Programs	222

1 HtDP Teachpacks

1.1 Manipulating Images: "image.rkt"

```
(require htdp/image)    package: htdp-lib
```

NOTE: This library is deprecated; use `2htdp/image`, instead. For the foreseeable time, we will continue to support the teachpack for your existing programs.

The teachpack provides functions for constructing and manipulating images. Basic, colored images are created as outlines or solid shapes. Additional functions allow for the composition of images.

1.1.1 Images

```
(image? x) → boolean?  
x : any/c
```

Is *x* an image?

```
(image=? x y) → boolean?  
x : image?  
y : image?
```

Are *x* and *y* the same image?

1.1.2 Modes and Colors

```
Mode (one-of/c 'solid 'outline "solid" "outline")
```

A Mode is used to specify whether painting a shape fills or outlines the form.

```
(struct color (red green blue)  
 #:extra-constructor-name make-color)  
red : (and/c natural-number/c (<=/c 255))  
green : (and/c natural-number/c (<=/c 255))  
blue : (and/c natural-number/c (<=/c 255))
```

RGB color?

A RGB describes a color via a shade of red, blue, and green colors (e.g., `(make-color 100 200 30)`).

`Color` (or/c symbol? string? color?)

A Color is a color-symbol (e.g., 'blue) or a color-string (e.g., "blue") or an RGB structure.

```
(image-color? x) → boolean?  
x : any
```

Determines if the input is a valid image Color.

1.1.3 Creating Basic Shapes

In DrRacket, you can insert images from your file system. Use PNG images whenever possible. In addition, you can create basic shapes with the following functions.

```
(rectangle w h m c) → image?  
w : (and/c number? (or/c zero? positive?))  
h : (and/c number? (or/c zero? positive?))  
m : Mode  
c : Color
```

Creates a w by h rectangle, filled in according to m and painted in color c

```
(circle r m c) → image?  
r : (and/c number? (or/c zero? positive?))  
m : Mode  
c : Color
```

Creates a circle or disk of radius r , filled in according to m and painted in color c

```
(ellipse w h m c) → image?  
w : (and/c number? (or/c zero? positive?))  
h : (and/c number? (or/c zero? positive?))  
m : Mode  
c : Color
```

Creates a w by h ellipse, filled in according to m and painted in color c

```
(triangle s m c) → image?  
s : number?  
m : Mode  
c : Color
```

Creates an upward pointing equilateral triangle whose side is *s* pixels long, filled in according to *m* and painted in color *c*

```
(star n outer inner m c) → image?  
n : (and/c number? (>=/c 2))  
outer : (and/c number? (>=/c 1))  
inner : (and/c number? (>=/c 1))  
m : Mode  
c : Color
```

Creates a multi-pointed star with *n* points, an *outer* radius for the max distance of the points to the center, and an *inner* radius for the min distance to the center.

```
(regular-polygon s r m c [angle]) → image?  
s : side  
r : number?  
m : Mode  
c : Color  
angle : real? = 0
```

Creates a regular polygon with *s* sides inscribed in a circle of radius *r*, using mode *m* and color *c*. If an angle is specified, the polygon is rotated by that angle.

```
(line x y c) → image?  
x : number?  
y : number?  
c : Color
```

Creates a line colored *c* from (0,0) to (*x*, *y*). See [add-line](#) below.

```
(text s f c) → Image  
s : string?  
f : (and/c number? positive?)  
c : Color
```

Creates an image of the text *s* at point size *f* and painted in color *c*.

1.1.4 Basic Image Properties

To understand how images are manipulated, you need to understand the basic properties of images.

```
(image-width i) → integer?  
i : image?
```

Obtain i 's width in pixels

```
(image-height i) → integer?  
i : image?
```

Obtain i 's height in pixels

For the composition of images, you must know about *pinholes*. Every image come with a pinhole. For images created with the above functions, the pinhole is at the center of the shape except for those created from `line` and `text`. The `text` function puts the pinhole at the upper left corner of the image, and `line` puts the pinhole at the beginning of the line (meaning that if the first two arguments to `line` are positive, the pinhole is also in the upper left corner). The pinhole can be moved, of course, and compositions locate pinholes according to their own rules. When in doubt you can always find out where the pinhole is and place it where convenient.

```
(pinhole-x i) → integer?  
i : image?
```

Determines the x coordinate of the pinhole, measuring from the left of the image.

```
(pinhole-y i) → integer?  
i : image?
```

Determines the y coordinate of the pinhole, measuring from the top (down) of the image.

```
(put-pinhole i x y) → image?  
i : image?  
x : number?  
y : number?
```

Creates a new image with the pinhole in the location specified by x and y , counting from the left and top (down), respectively.

```
(move-pinhole i delta-x delta-y) → image?  
i : image?  
delta-x : number?  
delta-y : number?
```

Creates a new image with the pinhole moved down and right by $delta-x$ and $delta-y$ with respect to its current location. Use negative numbers to move it up or left.

1.1.5 Composing Images

Images can be composed, and images can be found within compositions.

```
(add-line i x1 y1 x2 y2 c) → image?
  i : image?
  x1 : number?
  y1 : number?
  x2 : number?
  y2 : number?
  c : Color
```

Creates an image by adding a line (colored *c*) from (*x1,y1*) to (*x2,y2*) to image *i*.

```
(overlay img img2 img* ...) → image?
  img : image?
  img2 : image?
  img* : image?
```

Creates an image by overlaying all images on their pinholes. The pinhole of the resulting image is the same place as the pinhole in the first image.

```
(overlay/xy img delta-x delta-y other) → image?
  img : image?
  delta-x : number?
  delta-y : number?
  other : image?
```

Creates an image by adding the pixels of *other* to *img*.

Instead of lining the two images up on their pinholes, *other*'s pinhole is lined up on the point:

```
(make-posn (+ (pinhole-x img) delta-x)
           (+ (pinhole-y img) delta-y))
```

The pinhole of the resulting image is the same place as the pinhole in the first image.

The same effect can be had by combining `move-pinhole` and `overlay`,

```
(overlay img
        (move-pinhole other
                      (- delta-x)
                      (- delta-y)))
```

```
(image-inside? img other) → boolean?
  img : image?
  other : image?
```

Determines whether the pixels of the second image appear in the first.

Be careful when using this function with jpeg images. If you use an image-editing program to crop a jpeg image and then save it, `image-inside?` does not recognize the cropped image, due to standard compression applied to JPEG images.

```
(find-image img other) → posn?  
  img : image?  
  other : image?
```

Determines where the pixels of the second image appear in the first, with respect to the pinhole of the first image. If `(image-inside? img other)` isn't true, `find-image` signals an error.

1.1.6 Manipulating Images

Images can also be shrunk. These “shrink” functions trim an image by eliminating extraneous pixels.

```
(shrink-tl img width height) → image?  
  img : image?  
  width : number?  
  height : number?
```

Shrinks the image to a `width` by `height` image, starting from the *top-left* corner. The pinhole of the resulting image is in the center of the image.

```
(shrink-tr img width height) → image?  
  img : image?  
  width : number?  
  height : number?
```

Shrinks the image to a `width` by `height` image, starting from the *top-right* corner. The pinhole of the resulting image is in the center of the image.

```
(shrink-bl img width height) → image?  
  img : image?  
  width : number?  
  height : number?
```

Shrinks the image to a `width` by `height` image, starting from the *bottom-left* corner. The pinhole of the resulting image is in the center of the image.

```
(shrink-br img width height) → image?  
img : image?  
width : number?  
height : number?
```

Shrinks the image to a *width* by *height* image, starting from the *bottom-right* corner. The pinhole of the resulting image is in the center of the image.

```
(shrink img left above right below) → image?  
img : image?  
left : number?  
above : number?  
right : number?  
below : number?
```

Shrinks an image around its pinhole. The numbers are the pixels to save to left, above, to the right, and below the pinhole, respectively. The pixel directly on the pinhole is always saved.

1.1.7 Scenes

A *scene* is an image, but with the pinhole in the upper-left corner, i.e. an image where `pinhole-x` and `pinhole-y` both return 0.

Scenes are particularly useful with the `2htdp/universe` and `htdp/world` teachpacks, since it displays only scenes in its canvas.

```
(scene? x) → boolean?  
x : any/c
```

Is *x* an scene?

```
(empty-scene width height) → scene?  
width : natural-number/c  
height : natural-number/c
```

creates a plain white, *width* x *height* scene.

```
(place-image img x y s) → scene?  
img : image?  
x : number?  
y : number?  
s : scene?
```

creates a scene by placing *img* at (*x*, *y*) into *s*; (*x*, *y*) are computer graphics coordinates, i.e., they count right and down from the upper-left corner.

```
(nw:rectangle width
              height
              solid-or-outline
              c) → image?
width : natural-number/c
height : natural-number/c
solid-or-outline : Mode
c : Color
```

creates a *width* by *height* rectangle, solid or outlined as specified by *solid-or-outline* and colored according to *c*, with a pinhole at the upper left corner.

```
(scene+line s x0 y0 x1 y1 c) → scene?
s : scene?
x0 : number?
y0 : number?
x1 : number?
y1 : number?
c : Color
```

creates a scene by placing a line of color *c* from (*x0*, *y0*) to (*x1*, *y1*) using computer graphics coordinates. In contrast to the `add-line` function, `scene+line` cuts off those portions of the line that go beyond the boundaries of the given *s*.

1.1.8 Miscellaneous Image Manipulation and Creation

The last group of functions extracts the constituent colors from an image and converts a list of colors into an image.

```
List-of-color : list?
```

is one of:

```
; - empty
; - (cons Color List-of-color)
; Interpretation: represents a list of colors.
```

```
(image->color-list img) → List-of-color
img : image?
```

Converts an image to a list of colors.

```
(color-list->image l width height x y) → image?
  l : List-of-color
  width : natural-number/c
  height : natural-number/c
  x : natural-number/c
  y : natural-number/c
```

Converts a list of colors *l* to an image with the given *width* and *height* and pinhole (*x,y*) coordinates, specified with respect to the top-left of the image.

The remaining functions provide alpha-channel information as well. Alpha channels are a measure of transparency; 0 indicates fully opaque and 255 indicates fully transparent.

```
(struct alpha-color (alpha red green blue)
 #:extra-constructor-name make-alpha-color)
  alpha : (and/c natural-number/c (<=/c 255))
  red : (and/c natural-number/c (<=/c 255))
  green : (and/c natural-number/c (<=/c 255))
  blue : (and/c natural-number/c (<=/c 255))
```

A structure representing an alpha color.

```
(image->alpha-color-list img) → (list-of alpha-color?)
  img : image?
```

to convert an image to a list of alpha colors

```
(alpha-color-list->image l width height x y) → image?
  l : (list-of alpha-color?)
  width : integer?
  height : integer?
  x : integer?
  y : integer?
```

Converts a list of *alpha-colors* *l* to an image with the given *width* and *height* and pinhole (*x,y*) coordinates, specified with respect to the top-left of the image.

1.2 Simulations and Animations: "world.rkt"

```
(require htdp/world)      package: htdp-lib
```

NOTE: This library is deprecated; use `2htdp/universe`, instead. For guidance on how to convert your `htdp/world` programs to use `2htdp/universe`, see §2.9 “Porting World Programs to Universe”

Note: For a quick and educational introduction to the teachpack, see *How to Design Programs, Second Edition: Prologue*. As of August 2008, we also have a series of projects available as a small booklet on *How to Design Worlds*.

The purpose of this documentation is to give experienced Racketers a concise overview for using the library and for incorporating it elsewhere. The last section presents §1.2.3 “A First Example” for an extremely simple domain and is suited for a novice who knows how to design conditional functions for symbols.

The teachpack provides two sets of tools. The first allows students to create and display a series of animated scenes, i.e., a simulation. The second one generalizes the first by adding interactive GUI features.

1.2.1 Simple Simulations

```
(run-movie r m) → true
  r : (and/c real? positive?)
  m : [Listof image?]
```

`run-movie` displays the list of images `m` at the rate of `r` images per second.

```
(run-simulation w h r create-image) → true
  w : natural-number/c
  h : natural-number/c
  r : number?
  create-image : (-> natural-number/c scene)
```

creates and shows a canvas of width `w` and height `h`, starts a clock, making it tick every `r` (usually fractional) seconds. Every time the clock ticks, `run-simulation` applies `create-image` to the number of ticks passed since this function call. The results of these applications are displayed in the canvas.

Example:

```
(define (create-UFO-scene height)
  (place-image UFO 50 height (empty-scene 100 100)))

(define UFO
  (overlay (circle 10 'solid 'green)
           (rectangle 40 4 'solid 'green)))

(run-simulation 100 100 (/ 1 28) create-UFO-scene)
```

1.2.2 Interactions

An animation starts from a given “world” and generates new ones in response to events on the computer. This teachpack keeps track of the “current world” and recognizes three kinds of events: clock ticks; keyboard presses and releases; and mouse movements, mouse clicks, etc.

Your program may deal with such events via the *installation* of *handlers*. The teachpack provides for the installation of three event handlers: `on-tick-event`, `on-key-event`, and `on-mouse-event`. In addition, it provides for the installation of a `draw` handler, which is called every time your program should visualize the current world.

The following picture provides an intuitive overview of the workings of "world".

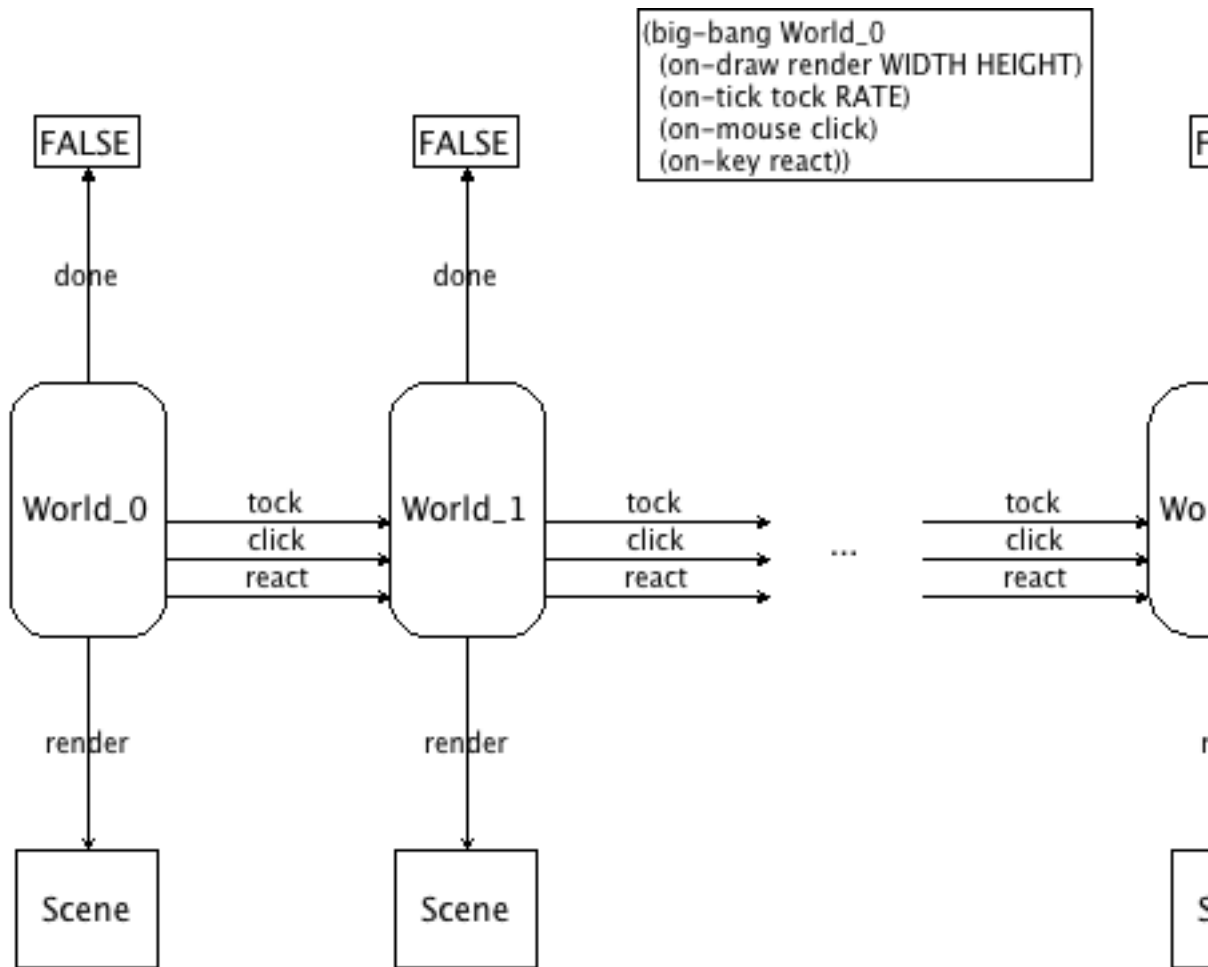

The `big-bang` function installs `World_0` as the initial world; the callbacks `tock`, `react`, and `click` transform one world into another one; `done` checks each time whether the world is final; and `draw` renders each world as a scene.

`World any/c`

For animated worlds and games, using the teachpack requires that you provide a data definition for `World`. In principle, there are no constraints on this data definition. You can even keep it implicit, even if this violates the Design Recipe.

```
(big-bang width height r world0) → true
width : natural-number/c
```

```

height : natural-number/c
r : number?
world0 : World
(big-bang width height r world0 animated-gif?) → true
width : natural-number/c
height : natural-number/c
r : number?
world0 : World
animated-gif? : boolean?

```

Creates and displays a *width* x *height* canvas, starts the clock, makes it tick every *r* seconds, and makes *world0* the current world. If it is called with five instead of four arguments and the last one (*animated-gif?*) is `true`, the teachpack allows the generation of images from the animation, including an animated GIF image.

```

(on-tick-event tock) → true
tock : (-> World World)

```

Tells `big-bang` to call *tock* on the current world every time the clock ticks. The result of the call becomes the current world.

KeyEvent (or/c *char?* *symbol?*)

A *KeyEvent* represents key board events, e.g., keys pressed or released, by the computer's user. A *char?* *KeyEvent* is used to signal that the user has hit an alphanumeric key. Symbols such as `'left`, `'right`, `'up`, `'down`, `'release` denote arrow keys or special events, such as releasing the key on the keypad.

```

(key-event? x) → boolean?
x : any

```

is *x* a *KeyEvent*

```

(key=? x y) → boolean?
x : key-event?
y : key-event?

```

compares two *KeyEvent* for equality

```

(on-key-event change) → true
change : (-> World key-event? World)

```

Tells `big-bang` to call *change* on the current world and a *KeyEvent* for every keystroke the user of the computer makes. The result of the call becomes the current world.

Here is a typical key-event handler:

```
(define (change w a-key-event)
  (cond
    [(key=? a-key-event 'left) (world-go w -DELTA)]
    [(key=? a-key-event 'right) (world-go w +DELTA)]
    [(char? a-key-event) w] ; to demonstrate order-free checking
    [(key=? a-key-event 'up) (world-go w -DELTA)]
    [(key=? a-key-event 'down) (world-go w +DELTA)]
    [else w]))
```

MouseEvent (one-of/c 'button-down 'button-up 'drag 'move 'enter 'leave)

A *MouseEvent* represents mouse events, e.g., mouse movements or mouse clicks, by the computer's user.

```
(on-mouse-event clack) → true
  clack : (-> World natural-number/c natural-number/c MouseEvent World)
```

Tells *big-bang* to call *clack* on the current world, the current *x* and *y* coordinates of the mouse, and a *MouseEvent* for every action of the mouse by the user of the computer. The result of the call becomes the current world.

```
(on-redraw to-scene) → true
  to-scene : (-> World Scene)
```

Tells *big-bang* to call *to-scene* whenever the canvas must be redrawn. The canvas is usually re-drawn after a tick event, a keyboard event, or a mouse event has occurred. The generated scene is displayed in the world's canvas.

```
(stop-when last-world?) → true
  last-world? : (-> World boolean?)
```

Tells *big-bang* to call *last-world?* whenever the canvas is drawn. If this call produces *true*, the clock is stopped; no more tick events, *KeyEvents*, or *MouseEvent*s are forwarded to the respective handlers. As a result, the canvas isn't updated either.

Example: The following examples shows that `(run-simulation 100 100 (/ 1 28) create-UFO-scene)` is a short-hand for three lines of code:

```
(define (create-UFO-scene height)
  (place-image UFO 50 height (empty-scene 100 100)))

(define UFO
  (overlay (circle 10 'solid 'green)
    (rectangle 40 4 'solid 'green)))
```

```
(big-bang 100 100 (/1 28) 0)
(on-tick-event add1)
(on-redraw create-UFO-scene)
```

Exercise: Add a condition for stopping the flight of the UFO when it reaches the bottom.

1.2.3 A First Example

Understanding a Door

Say we want to represent a door with an automatic door closer. If this kind of door is locked, you can unlock it. While this doesn't open the door per se, it is now possible to do so. That is, an unlocked door is closed and pushing at the door opens it. Once you have passed through the door and you let go, the automatic door closer takes over and closes the door again. Of course, at this point you could lock it again.

Here is a picture that translates our words into a graphical representation:

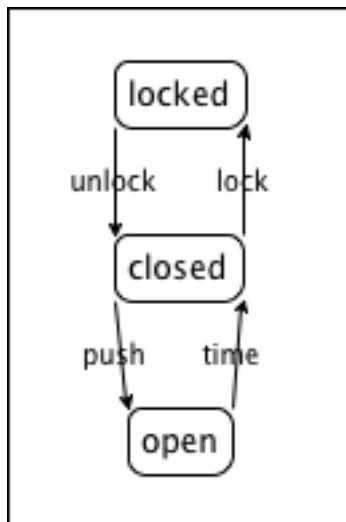

The picture displays a so-called "state machine". The three circled words are the states that our informal description of the door identified: locked, closed (and unlocked), and open. The arrows specify how the door can go from one state into another. For example, when the door is open, the automatic door closer shuts the door as time passes. This transition is indicated by the arrow labeled "time passes." The other arrows represent transitions in a similar manner:

- "push" means a person pushes the door open (and let's go);

- "lock" refers to the act of inserting a key into the lock and turning it to the locked position; and
- "unlock" is the opposite of "lock".

Simulations of the World

Simulating any dynamic behavior via a program demands two different activities. First, we must tease out those portions of our "world" that change over time or in reaction to actions, and we must develop a data representation D for this information. Keep in mind that a good data definition makes it easy for readers to map data to information in the real world and vice versa. For all other aspects of the world, we use global constants, including graphical or visual constants that are used in conjunction with the rendering functions.

Second, we must translate the "world" actions—the arrows in the above diagram—into interactions with the computer that the world teachpack can deal with. Once we have decided to use the passing of time for one aspect and mouse movements for another, we must develop functions that map the current state of the world—represented as data—into the next state of the world. Since the data definition D describes the class of data that represents the world, these functions have the following general contract and purpose statements:

```

; tick : D -> D
; deal with the passing of time
(define (tick w) ...)

; click : D Number Number MouseEvent -> D
; deal with a mouse click at (x,y) of kind me
; in the current world w
(define (click w x y me) ...)

; control : D KeyEvent -> D
; deal with a key event (symbol, char) ke
; in the current world w
(define (control w ke) ...)

```

That is, the contracts of the various hooks dictate what the contracts of these functions are once we have defined how to represent the world in data.

A typical program does not use all three of these actions and functions but often just one or two. Furthermore, the design of these functions provides only the top-level, initial design goal. It often demands the design of many auxiliary functions.

Simulating a Door: Data

Our first and immediate goal is to represent the world as data. In this specific example, the world consists of our door and what changes about the door is whether it is locked, unlocked but closed, or open. We use three symbols to represent the three states:

SD

```
; DATA DEF.  
; The state of the door (SD) is one of:  
; - 'locked  
; - 'closed  
; - 'open
```

Symbols are particularly well-suited here because they directly express the state of the door.

Now that we have a data definition, we must also decide which computer actions and interactions should model the various actions on the door. Our pictorial representation of the door's states and transitions, specifically the arrow from "open" to "closed" suggests the use of a function that simulates time. For the other three arrows, we could use either keyboard events or mouse clicks or both. Our solution uses three keystrokes: `#\u` for unlocking the door, `#\l` for locking it, and `#\space` for pushing it open. We can express these choices graphically by translating the above "state machine" from the world of information into the world of data:

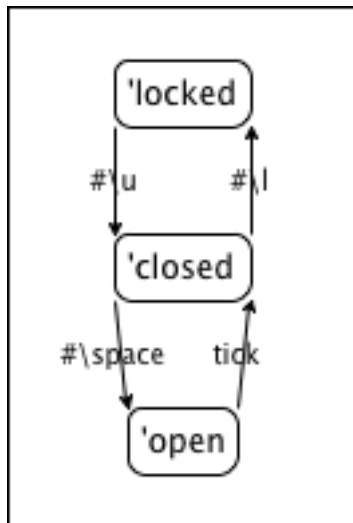

Simulating a Door: Functions

Our analysis and data definition leaves us with three functions to design:

- `automatic-closer`, which closes the door during one tick;
- `door-actions`, which manipulates the door in response to pressing a key; and
- `render`, which translates the current state of the door into a visible scene.

Let's start with `automatic-closer`. We know its contract and it is easy to refine the purpose statement, too:

```
; automatic-closer : SD -> SD
; closes an open door over the period of one tick
(define (automatic-closer state-of-door) ...)
```

Making up examples is trivial when the world can only be in one of three states:

given state	desired state
'locked	'locked
'closed	'closed
'open	'closed

```
; automatic-closer : SD -> SD
; closes an open door over the period of one tick

(check-expect (automatic-closer 'locked) 'locked)
(check-expect (automatic-closer 'closed) 'closed)
(check-expect (automatic-closer 'open) 'closed)

(define (automatic-closer state-of-door) ...)
```

The template step demands a conditional with three clauses:

```
(define (automatic-closer state-of-door)
  (cond
    [(symbol=? 'locked state-of-door) ...]
    [(symbol=? 'closed state-of-door) ...]
    [(symbol=? 'open state-of-door) ...])))
```

The examples basically dictate what the outcomes of the three cases must be:

```
(define (automatic-closer state-of-door)
  (cond
    [(symbol=? 'locked state-of-door) 'locked]
    [(symbol=? 'closed state-of-door) 'closed]
    [(symbol=? 'open state-of-door) 'closed])))
```

Don't forget to run the example-tests.

For the remaining three arrows of the diagram, we design a function that reacts to the three chosen keyboard events. As mentioned, functions that deal with keyboard events consume both a world and a keyevent:

```

; door-actions : SD Keyevent -> SD
; key events simulate actions on the door
(define (door-actions s k) ...)

```

given state	given keyevent	desired state
'locked	#\u	'closed
'closed	#\l	'locked
'closed	#\space	'open
'open	—	'open

The examples combine what the above picture shows and the choices we made about mapping actions to keyboard events.

From here, it is straightforward to turn this into a complete design:

```

(define (door-actions s k)
  (cond
    [(and (symbol=? 'locked s) (key=? #\u k)) 'closed]
    [(and (symbol=? 'closed s) (key=? #\l k)) 'locked]
    [(and (symbol=? 'closed s) (key=? #\space k)) 'open]
    [else s]))

(check-expect (door-actions 'locked #\u) 'closed)
(check-expect (door-actions 'closed #\l) 'locked)
(check-expect (door-actions 'closed #\space) 'open)
(check-expect (door-actions 'open 'any) 'open)
(check-expect (door-actions 'closed 'any) 'closed)

```

Last but not least we need a function that renders the current state of the world as a scene. For simplicity, let's just use a large enough text for this purpose:

```

; render : SD -> Scene
; translate the current state of the door into a large text
(define (render s)
  (text (symbol->string s) 40 'red))

(check-expect (render 'closed) (text "closed" 40 'red))

```

The function `symbol->string` translates a symbol into a string, which is needed because `text` can deal only with the latter, not the former. A look into the language documentation revealed that this conversion function exists, and so we use it.

Once everything is properly designed, it is time to *run* the program. In the case of the world teachpack, this means we must specify which function takes care of tick events, key events, and redraws:

```
(big-bang 100 100 1 'locked)
(on-tick-event automatic-closer)
(on-key-event door-actions)
(on-redraw render)
```

Now it's time for you to collect the pieces and run them in `big-bang` to see whether it all works.

1.3 Converting Temperatures: "convert.rkt"

```
(require htdp/convert)      package: htdp-lib
```

The teachpack `convert.rkt` provides three functions for converting Fahrenheit temperatures to Celsius. It is useful for a single exercise in HtDP. Its purpose is to demonstrate the independence of “form” (user interface) and “function” (also known as “model”).

```
(convert-gui convert) → true
  convert : (-> number? number?)
```

Consumes a conversion function from Fahrenheit to Celsius and creates a graphical user interface with two rulers, which users can use to convert temperatures according to the given temperature conversion function.

```
(convert-repl convert) → true
  convert : (-> number? number?)
```

Consumes a conversion function from Fahrenheit to Celsius and then starts a read-evaluate-print loop. The loop prompts users to enter a number and then converts the number according to the given temperature conversion function. A user can exit the loop by entering “x.”

```
(convert-file in convert out) → true
  in : string?
  convert : (-> number? number?)
  out : string?
```

Consumes a file name `in`, a conversion function from Fahrenheit to Celsius, and a string `out`. The program then reads all the number from `in`, converts them according to `convert`, and prints the results to the newly created file `out`.

Warning: If `out` already exists, it is deleted.

Example: Create a file with name `"in.dat"` with some numbers in it, using your favorite text editor on your computer. Define a function `f2c` in the Definitions window and set teachpack to `"convert.rkt"` and click Run. Then evaluate

```
(convert-gui f2c)
; and
(convert-file "in.dat" f2c "out.dat")
; and
(convert-repl f2c)
```

Finally inspect the file `"out.dat"` and use the repl to check the answers.

1.4 Guessing Numbers: "guess.rkt"

```
(require htdp/guess)      package: htdp-lib
```

The teachpack provides functions to play a guess-the-number game. Each function display a GUI in which a player can choose specific values for some number of digits and then check the guess. The more advanced functions ask students to implement more of the game.

```
(guess-with-gui check-guess) → true
  check-guess : (-> number? number? symbol?)
```

The `check-guess` function consumes two numbers: `guess`, which is the user's guess, and `target`, which is the randomly chosen number-to-be-guessed. The result is a symbol that reflects the relationship of the player's guess to the target.

```
(guess-with-gui-3 check-guess) → true
  check-guess : (-> digit? digit? digit? number? symbol?)
```

The `check-guess` function consumes three digits (`digit0`, `digit1`, `digit2`) and one number (`target`). The latter is the randomly chosen number-to-be-guessed; the three digits are the current guess. The result is a symbol that reflects the relationship of the player's guess (the digits converted to a number) to the target.

Note: `digit0` is the *least* significant digit that the user chose and `digit2` is the *most* significant one.

```
(guess-with-gui-list check-guess) → true
  check-guess : (-> (list-of digit?) number? symbol?)
```

The `check-guess` function consumes a list of digits (`digits`) and a number (`target`). The former is a list that makes up the user's guess, and the latter is the randomly chosen number-to-be-guessed. The result is a symbol that reflects the relationship of the player's guess (the digits converted to a number) to the target.

Note: the first item on `digits` is the *least* significant digit that the user chose, and the last one is the *most* significant digit.

1.5 MasterMinding: "master.rkt"

```
(require htdp/master)      package: htdp-lib
```

The teachpack implements GUI for playing a simple master mind-like game, based on a function designed by a student. The player clicks on two colors and the program responds with an answer that indicates how many colors and places were correct.

```
(master check-guess) → symbol?  
  check-guess : (-> symbol? symbol? symbol? symbol? boolean?)
```

Chooses two “secret” colors and then opens a graphical user interface for playing *MasterMind*. The player is prompted to choose two colors, via a choice tablet and mouse clicks. Once chosen, `master` uses `check-guess` to compare them.

If the two guesses completely match the two secret colors, `check-guess` must return `'PerfectGuess`; otherwise it must return a different, informative symbol.

1.6 Playing MasterMind: "master-play.rkt"

```
(require htdp/master-play)  package: htdp-lib
```

The teachpack implements the MasterMind game so that students can play the game and get an understanding of what we expect from them.

```
(go name) → true  
  name : symbol?
```

chooses a “secret” three-letter word, opens a canvas and a menu, and asks the player to guess the word.

1.7 Simple Drawing: "draw.rkt"

```
(require htdp/draw)        package: htdp-lib
```

The teachpack provides two sets of functions: one for drawing into a canvas and one for reacting to canvas events.

NOTE: This library is deprecated; use `2htdp/image` (probably in conjunction with `2htdp/universe`), instead. You may continue to use the library for solving exercises from *How To Design Programs, First Edition* but do consider switching to *How To Design Programs, Second Edition* instead.

1.7.1 Drawing on a Canvas

DrawColor: (and/c symbol? (one-of/c 'white 'yellow 'red 'blue 'green 'black)) These six colors are definitely provided. If you want other colors, guess! For example, 'orange works, but 'mauve doesn't. If you apply the function to a symbol that it doesn't recognize as a color, it raises an error.

```
(start width height) → true  
width : number?  
height : number?
```

Opens a *width* x *height* canvas.

```
(start/cartesian-plane width height) → true  
width : number?  
height : number?
```

Opens a *width* x *height* canvas and draws a Cartesian plane.

```
(stop) → true
```

Closes the canvas.

```
(draw-circle p r c) → true  
p : posn?  
r : number?  
c : DrawColor
```

Draws a *c* circle at *p* with radius *r*.

```
(draw-solid-disk p r c) → true  
p : posn?  
r : number?  
c : DrawColor
```

Draws a *c* disk at *p* with radius *r*.

```
(draw-solid-rect ul width height c) → true  
ul : posn?  
width : number?  
height : number?  
c : DrawColor
```

Draws a *width* x *height*, *c* rectangle with the upper-left corner at *ul*.

```
(draw-solid-line strt end c) → true
  strt : posn?
  end : posn?
  c : DrawColor
```

Draws a *c* line from *strt* to *end*.

```
(draw-solid-string p s) → true
  p : posn?
  s : string?
```

Draws *s* at *p*.

```
(sleep-for-a-while s) → true
  s : number?
```

Suspends evaluation for *s* seconds.

The teachpack also provides `clear-` functions for each `draw-` function:

```
(clear-circle p r c) → true
  p : posn?
  r : number?
  c : DrawColor
```

clears a *c* circle at *p* with radius *r*.

```
(clear-solid-disk p r c) → true
  p : posn?
  r : number?
  c : DrawColor
```

clears a *c* disk at *p* with radius *r*.

```
(clear-solid-rect ul width height c) → true
  ul : posn?
  width : number?
  height : number?
  c : DrawColor
```

clears a *width* x *height*, *c* rectangle with the upper-left corner at *ul*.

```
(clear-solid-line strt end c) → true
  strt : posn?
  end : posn?
  c : DrawColor
```

clears a *c* line from *strt* to *end*.

```
(clear-solid-string p s) → true
  p : posn?
  s : string?
```

clears *s* at *p*.

```
(clear-all) → true
```

clears the entire screen.

1.7.2 Interactions with Canvas

```
(wait-for-mouse-click) → posn?
```

Waits for the user to click on the mouse, within the canvas.

DrawKeyEvent: (or/c char? symbol?) A *DrawKeyEvent* represents keyboard events:

- *char?*, if the user pressed an alphanumeric key;
- *symbol?*, if the user pressed, for example, an arrow key: 'up 'down 'left 'right

```
(get-key-event) → (or/c false DrawKeyEvent)
```

Checks whether the user has pressed a key within the window; *false* if not.

DrawWorld: For proper interactions, using the teachpack requires that you provide a data definition for *DrawWorld*. In principle, there are no constraints on this data definition. You can even keep it implicit, even if this violates the Design Recipe.

The following functions allow programs to react to events from the canvas.

```
(big-bang n w) → true
  n : number?
  w : DrawWorld
```

Starts the clock, one tick every *n* (fractal) seconds; *w* becomes the first “current” world.

```
(on-key-event change) → true
  change : (-> DrawKeyEvent DrawWorld DrawWorld)
```

Adds *change* to the world. The function reacts to keyboard events and creates a new DrawWorld.

```
(on-tick-event tock) → true  
tock : (-> DrawWorld DrawWorld)
```

Adds *tock* to the world. The function reacts to clock tick events, creating a new current world.

```
(end-of-time) → DrawWorld
```

Stops the world; returns the current world.

1.8 Hangman: "hangman.rkt"

```
(require htdp/hangman)    package: htdp-lib
```

The teachpack implements the callback functions for playing a *Hangman* game, based on a function designed by a student. The player guesses a letter and the program responds with an answer that indicates how many times, if at all, the letter occurs in the secret word.

```
(hangman make-word reveal draw-next-part) → true  
make-word : (-> symbol? symbol? symbol? word?)  
reveal : (-> word? word? word?)  
draw-next-part : (-> symbol? true)
```

Chooses a “secret” three-letter word and uses the given functions to manage the *Hangman* game.

```
(hangman-list reveal-for-list  
              draw-next-part) → true  
reveal-for-list : (-> symbol? (list-of symbol?) (list-of symbol?)  
                    (list-of symbol?))  
draw-next-part : (-> symbol? true)
```

Chooses a “secret” word—a list of symbolic letters—and uses the given functions to manage the *Hangman* game: *reveal-for-list* determines how many times the chosen letter occurs in the secret word; *draw-next-part* is given the symbolic name of a body part and draws it on a separately managed canvas.

In addition, the teachpack re-exports the entire functionality of the drawing library; see §1.7 “Simple Drawing: "draw.rkt"” for documentation.

1.9 Playing Hangman: "hangman-play.rkt"

```
(require htdp/hangman-play)    package: htdp-lib
```

The teachpack implements the Hangman game so that students can play the game and get an understanding of what we expect from them.

```
(go name) → true  
  name : symbol?
```

chooses a “secret” three-letter word, opens a canvas and a menu, and asks the player to guess the word.

1.10 Managing Control Arrows: "arrow.rkt"

```
(require htdp/arrow)          package: htdp-lib
```

The teachpack implements a controller for moving shapes across a canvass.

```
(control-left-right shape n move draw) → true  
  shape : Shape  
  n : number?  
  move : (-> number? Shape Shape)  
  draw : (-> Shape true)
```

Moves shape *n* pixels left (negative) or right (positive).

```
(control-up-down shape n move draw) → true  
  shape : Shape  
  n : number?  
  move : (-> number? Shape Shape)  
  draw : (-> Shape true)
```

Moves shape *n* pixels up (negative) or down (positive).

```
(control shape n move-lr move-ud draw) → true  
  shape : Shape  
  n : number?  
  move-lr : (-> number? Shape Shape)  
  move-ud : (-> number? Shape Shape)  
  draw : (-> Shape true)
```

Moves shape *N* pixels left or right and up or down, respectively.

The teachpack also provides four images:

`LEFT-ARROW` : image?

an arrow pointing left.

`RIGHT-ARROW` : image?

an arrow pointing right.

`UP-ARROW` : image?

an arrow pointing up.

`DOWN-ARROW` : image?

an arrow pointing down.

Example:

```
; A shape is a structure:
; (make-posn num num)

; RAD : the radius of the simple disk moving across a canvas
(define RAD 10)

; move : number shape -> shape or false
; to move a shape by delta according to translate
; effect: to redraw it
(define (move delta sh)
  (cond
    [(and (clear-solid-disk sh RAD)
          (draw-solid-disk (translate sh delta) RAD))
     (translate sh delta)]
    [else false]))

; translate : shape number -> shape
; to translate a shape by delta in the x direction
(define (translate sh delta)
  (make-posn (+ (posn-x sh) delta) (posn-y sh)))

; draw-it : shape -> true
; to draw a shape on the canvas: a disk with radius
(define (draw-it sh)
```

```

(draw-solid-disk sh RAD))

; Run:

; this creates the canvas
(start 100 50)

; this creates the controller GUI
(control-left-right (make-posn 10 20) 10 move draw-it)

```

1.11 Manipulating Simple HTML Documents: "docs.rkt"

```
(require htdp/docs)      package: htdp-lib
```

The teachpack provides three functions for creating simple “HTML” documents:

Annotation An Annotation is a symbol that starts with “<” and ends in “>”. An end annotation is one that starts with “</”.

```
(atom? x) → boolean?
x : any/c
```

Determines whether or not a value is a number, a symbol, or a string.

```
(annotation? x) → boolean?
x : any/c
```

Determines whether or not a symbol is a document annotation.

```
(end-annotation x) → Annotation
x : Annotation
```

Consumes an annotation and produces a matching ending annotation.

```
(write-file l) → true
l : (list-of atom)
```

Consumes a list of symbols and annotations and prints them out as a "file".

Sample session: set teachpack to "docs.rkt" and click Run:

```

> (annotation? 0)
false
> (annotation? '<bold>)

```

```

true
> (end-annotation 0)
end-annotation: not an annotation: 0
> (write-file (list 'a 'b))
a b

```

1.12 Working with Files and Directories: "dir.rkt"

```
(require htdp/dir)      package: htdp-lib
```

The teachpack provides structures and functions for working with files and directories:

```
(struct dir (name dirs files)
 #:extra-constructor-name make-dir)
name : (or/c string? symbol?)
dirs : (listof dir?)
files : (listof file?)
```

Represents directories (file folders) in the teaching languages.

```
(struct file (name size date content)
 #:extra-constructor-name make-file)
name : (or/c string? symbol?)
size : integer?
date : (or/c 0 date?)
content : any/c
```

Represents files in the teaching languages. The struct's `date` field is optional for clients. Calling `make-file` with three arguments fills the time field with 0.

```
(create-dir path) → dir?
path : string?
```

Turns the directory found at `path` on your computer into an instance of `dir`.

```
(struct date (year month day hours minutes seconds)
 #:extra-constructor-name make-date)
year : natural-number/c
month : natural-number/c
day : natural-number/c
hours : natural-number/c
minutes : natural-number/c
seconds : natural-number/c
```

Represents dates for file construction.

Sample: Set teachpack to "dir.rkt" or add (require htdp/dir) to the definitions area. Clicking on Run and asking for the content of the current directory will produce something like this:

```
> (create-dir ".")
(make-dir
  "."
  '()
  (cons (make-file "arrow.scrbl" 1897 (make-
date 15 1 15 11 22 21) "")
    (cons (make-file "convert.scrbl" 2071 (make-
date 15 1 15 11 22 21) "")
      (cons (make-file "dir.scrbl" 1587 (make-
date 8 7 8 9 23 52) "")
        (cons (make-file "docs.scrbl" 1259 (make-
date 15 1 15 11 22 21) "")
          (cons (make-file "draw.scrbl" 5220 (make-
date 15 1 15 11 22 21) "")
            (cons (make-file "elevator.scrbl" 1110 (make-
date 15 1 15 11 22 21) ""))))))))))
```

Using "." usually means the directory in which your program is located. In this case, the directory contains no sub-directories and six files.

Note The library generates file names as strings, but the constructors accept symbols for backwards compatibility.

Note Soft links are always treated as if they were empty files.

Changed in version 1.0 of package htdp-lib: built in 1996 for HtDP/1e

Changed in version 1.4: Fri Jul 8 13:09:13 EDT 2016 added optional date field to file representation, added strings as representations of file names

1.13 Graphing Functions: "graphing.rkt"

```
(require htdp/graphing)      package: htdp-lib
```

The teachpack provides two functions for graphing functions in the regular (upper right) quadrant of the Cartesian plane (between 0 and 10 in both directions):

```
(graph-fun f color) → true
  f : (-> number? number?)
  color : symbol?
```

Draws the graph of f with the given *color*.

```
(graph-line line color) → true
  line : (-> number? number?)
  color : symbol?
```

Draws *line*, a function representing a straight line, with a given color.

For color symbols, see §1.7 “Simple Drawing: “draw.rkt””.

In addition, the teachpack re-exports the entire functionality of the drawing library; see §1.7 “Simple Drawing: “draw.rkt”” for documentation.

1.14 Simple Graphical User Interfaces: “gui.rkt”

```
(require htdp/gui)      package: htdp-lib
```

The teachpack provides functions for creating and manipulating graphical user interfaces. We recommend using `2htdp/universe` instead.

Window A Window is a data representation of a visible window on your computer screen.

GUI-ITEM A GUI-Item is a data representation of an active component of a window on your computer screen.

```
(create-window g) → Window
  g : (listof (listof GUI-ITEM))
```

Creates a window from the “matrix” of gui items *g*.

```
(window? x) → boolean?
  x : any/c
```

Is the given value a window?

```
(show-window w) → true
  w : Window
```

Shows *w*.

```
(hide-window w) → true
  w : window
```

Hides *w*.

```
(make-button label callback) → GUI-ITEM
  label : string>
  callback : (-> event% boolean)
```

Creates a button with *label* and *callback* function. The latter receives an argument that it may safely ignore.

```
(make-message msg) → GUI-ITEM
  msg : string?
```

Creates a message item from *msg*.

```
(draw-message g m) → true
  g : GUI-ITEM
  m : string?
```

Displays *m* in message item *g* and erases the current message.

```
(make-text txt) → GUI-ITEM
  txt : string?
```

Creates a text editor (with label *txt*) that allows users to enter text.

```
(text-contents g) → string?
  g : GUI-ITEM
```

Determines the current contents of a text GUI-ITEM.

```
(make-choice choices) → GUI-ITEM
  choices : (listof string?)
```

Creates a choice menu from *choices* that permits users to choose from some alternatives.

```
(choice-index g) → natural-number/c
  g : GUI-ITEM
```

Determines the choice that is currently selected in a choice GUI-ITEM; the result is the 0-based index in the choice menu

Example 1:

```
> (define w
  (create-window
```

```

      (list (list (make-button "QUIT" (lambda (e) (hide-
window w))))))
; A button appears on the screen.
; Click on the button and it will disappear.
> (show-window w)
; The window disappears.

```

Example 2:

```

; text1 : GUI-ITEM
(define text1
  (make-text "Please enter your name"))

; msg1 : GUI-ITEM
(define msg1
  (make-message (string-append "Hello, World" (make-
string 33 #\space))))

; Event -> true
; draws the current contents of text1 into msg1, prepended with
"Hello, "
(define (respond e)
  (draw-message msg1 (string-append "Hello, " (text-
contents text1))))

; set up window with three "lines":
;   a text field, a message, and two buttons
; fill in text and click OKAY
(define w
  (create-window
    (list
      (list text1)
      (list msg1)
      (list (make-button "OKAY" respond)
            (make-button "QUIT" (lambda (e) (hide-window w)))))))

```

1.15 An Arrow GUI: "arrow-gui.rkt"

```
(require htdp/arrow-gui)      package: htdp-lib
```

The teachpack provides functions for creating and manipulating an arrow GUI. We recommend using `2htdp/universe` instead.

```
modelT (-> button% event% true)
```

A modelT is a function that accepts and ignores two arguments.

```
(control) → symbol?
```

Reads out the current state of the message field.

```
(view s) → true  
s : (or/c string? symbol?)
```

Displays *s* in the message field.

```
(connect l r u d) → true  
l : modelT  
r : modelT  
u : modelT  
d : modelT
```

Connects four controllers with the four directions in the arrow window.

Example:

```
; Advanced  
(define (make-model dir)  
  (lambda (b e)  
    (begin  
      (view dir)  
      (printf "~a ~n" (control))))))  
  
(connect (make-model "left")  
         (make-model "right")  
         (make-model "up")  
         (make-model "down"))
```

Now click on the four arrows. The message field contains the current direction, the print-out the prior contents of the message field.

1.16 Controlling an Elevator: "elevator.rkt"

```
(require htdp/elevator)    package: htdp-lib
```

The teachpack implements an elevator simulator.

It displays an eight-floor elevator and accepts mouse clicks from the user, which are translated into service demands for the elevator.

```
(run NextFloor) → any/c
  NextFloor : number?
```

Creates an elevator simulator that is controlled by *NextFloor*. This function consumes the current floor, the direction in which the elevator is moving, and the current demands. From that, it computes where to send the elevator next.

Example: Define a function that consumes the current state of the elevator (three arguments) and returns a number between 1 and 8. Here is a non-sensical definition:

```
(define (controller x y z) 7)
```

It moves the elevator once, to the 7th floor.

Second, set the teachpack to "elevator.rkt", click Run, and evaluate

```
(run controller)
```

1.17 Lookup GUI: "lkup-gui.rkt"

```
(require htdp/lkup-gui)      package: htdp-lib
```

The teachpack provides three functions:

```
(control index) → symbol?
  index : natural-number?
```

reads out the *index*th guess choice, starting with 0

```
(view msg) → true/c
  msg : (or/c string? symbol?)
```

displays its *msg* argument in the message panel

```
(connect event-handler) → true/c
  event-handler : (-> button% event% true/c)
```

connects a controller (*handler*) with the Check button displays frame

Example:

```
(connect
  (lambda (e b)
    (view (control))))
```

This example simply mirrors what the user types in to the message field.

1.18 Guess GUI: "guess-gui.rkt"

```
(require htdp/guess-gui)      package: htdp-lib
```

The teachpack provides three functions:

```
(control index) → symbol?  
  index : natural-number?
```

reads out the *index*th guess choice, starting with 0

```
(view msg) → true/c  
  msg : (or/c string? symbol?)
```

displays its *msg* argument in the message panel

```
(connect handler) → true/c  
  handler : (-> button% event% true/c)
```

connects a controller (*handler*) with the Check button displays frame

Example:

```
(connect (lambda (e b)  
  (begin  
    (printf "0th digit: ~s~n" (control 0))  
    (view (control 0))))))
```

1.19 Queens: "show-queen.rkt"

```
(require htdp/show-queen)    package: htdp-lib
```

The teachpack provides the function `show-queen`, which implements a GUI for exploring the n-queens problem.

```
(show-queen board) → true  
  board : (list-of (list-of boolean?))
```

The function `show-queen` consumes a list of lists of booleans that describes a *board*. Each of the inner lists must have the same length as the outer list. The `true`s correspond to positions where queens are, and the `false`s correspond to empty squares. The function returns nothing.

In the GUI window that `show-queen` opens, the red and orange dots show where the queens are. The green dot shows where the mouse cursor is. Each queen that threatens the green spot is shown in red, and the queens that do not threaten the green spot are shown in orange.

1.20 Matrix Functions: "matrix.rkt"

```
(require htdp/matrix)    package: htdp-lib
```

The experimental teachpack supports matrices and matrix functions. A matrix is just a rectangle of 'objects'. It is displayed as an image, just like the images from §1.1 "Manipulating Images: "image.rkt"". Matrices are images and, indeed, scenes in the sense of the §1.2 "Simulations and Animations: "world.rkt"".

No educational materials involving matrices exist.

The functions access a matrix in the usual (school-mathematics) manner: row first, column second.

The functions aren't tuned for efficiency so don't expect to build programs that process lots of data.

Rectangle A Rectangle (of X) is a non-empty list of lists containing X where all elements of the list are lists of equal (non-zero) length.

```
(matrix? o) → boolean?  
o : any/c
```

determines whether the given object is a matrix?

```
(matrix-rows m) → natural-number/c  
m : matrix?
```

determines how many rows this matrix *m* has

```
(matrix-cols m) → natural-number/c  
m : matrix?
```

determines how many columns this matrix *m* has

```
(rectangle->matrix r) → matrix?  
r : Rectangle
```

creates a matrix from the given Rectangle

```
(matrix->rectangle m) → Rectangle  
m : matrix?
```

creates a rectangle from this matrix *m*

```
(make-matrix n m l) → matrix?
  n : natural-number/c
  m : natural-number/c
  l : (Listof X)
```

creates an n by m matrix from l

NOTE: `make-matrix` would consume an optional number of entries, if it were like `make-vector`

```
(build-matrix n m f) → matrix?
  n : natural-number/c
  m : natural-number/c
  f : (-> (and/c natural-number/c (</c m))
          (and/c natural-number/c (</c n))
          any/c)
```

creates an n by m matrix by applying f to $(0,0)$, $(0,1)$, ..., $((\text{sub1 } m), (\text{sub1 } n))$

```
(matrix-ref m i j) → any/c
  m : matrix?
  i : (and/c natural-number/c (</c (matrix-rows m)))
  j : (and/c natural-number/c (</c (matrix-rows m)))
```

retrieve the item at (i,j) in matrix m

```
(matrix-set m i j x) → matrix?
  m : matrix?
  i : (and/c natural-number/c (</c (matrix-rows m)))
  j : (and/c natural-number/c (</c (matrix-rows m)))
  x : any/c
```

creates a new matrix with x at (i,j) and all other places the same as in m

```
(matrix-where? m pred?) → (listof posn?)
  m : matrix?
  pred? : (-> any/c boolean?)
```

`(matrix-where? M P)` produces a list of `(make-posn i j)` such that `(P (matrix-ref M i j))` holds

```
(matrix-render m) → Rectangle
  m : matrix?
```

renders this matrix m as a rectangle of strings

```
(matrix-minor m i j) → matrix?  
  m : matrix?  
  i : (and/c natural-number/c (</c (matrix-rows m)))  
  j : (and/c natural-number/c (</c (matrix-rows m)))
```

creates a matrix minor from *m* at (*i*,*j*)

1.20.1 Matrix Snip

The `htdp/matrix` teachpack exports the `snip-class` object to support saving and reading matrix snips.

```
snip-class : (instance/of matrix-snip-class%)
```

An object to support 2D matrix rendering.

2 HtDP/2e Teachpacks

2.1 Batch Input/Output: "batch-io.rkt"

```
(require 2htdp/batch-io)    package: htdp-lib
```

The batch-io teachpack introduces several functions and a form for reading content from files and one function for writing to a file.

2.1.1 IO Functions

All functions that read a file consume the name of a file and possibly additional arguments. They assume that the specified file exists in the same folder as the program; if not they signal an error:

- ```
(read-file f) → string?
 f : (or/c 'standard-in 'stdin (and/c string? file-exists?))
```

reads the standard input device (until closed) or the content of file *f* and produces it as a string, including newlines.

Example:

```
> (read-file "data.txt")
"hello world \n good bye \n\ni, for 1, am done "
```

assuming the file named "data.txt" has this shape:

```
hello world
 good bye

i, for 1, am done
```

Note how the leading space in the second line translates into the space between the newline indicator and the word "good" in the result.

- ```
(read-1strings f) → (listof 1string?)  
  f : (or/c 'standard-in 'stdin (and/c string? file-exists?))
```

reads the standard input device (until closed) or the content of file *f* and produces it as a list of one-char strings, one per character.

Example:

```
> (read-1strings "data.txt")
'("h"
  "e"
  "l"
  "l"
  "o"
  " "
  "w"
  "o"
  "r"
  "l"
  "d"
  " "
  "\n"
  " "
  "g"
  "o"
  "o"
  "d"
  " "
  "b"
  "y"
  "e"
  " "
  "\n"
  "\n"
  "i"
  ","
  " "
  "f"
  "o"
  "r"
  " "
  "1"
  ","
  " "
  "a"
  "m"
  " "
  "d"
  "o"
  "n"
  "e"
  " ")
```

Note how this function reproduces all parts of the file faithfully, including spaces and

newlines.

- ```
(read-lines f) → (listof string?)
f : (or/c 'standard-in 'stdin (and/c string? file-exists?))
```

reads the standard input device (until closed) or the content of file *f* and produces it as a list of strings, one per line.

Example:

```
> (read-lines "data.txt")
'("hello world " " good bye " "" "i, for 1, am done ")
```

when "data.txt" is the name of the same file as in the preceding item. And again, the leading space of the second line shows up in the second string in the list.

If the last line is not terminated by a newline, the functions acts as if there were one.

- ```
(read-words f) → (listof string?)  
f : (or/c 'standard-in 'stdin (and/c string? file-exists?))
```

reads the standard input device (until closed) or the content of file *f* and produces it as a list of strings, one per white-space separated token in the file.

Example:

```
> (read-words "data.txt")  
'("hello" "world" "good" "bye" "i," "for" "1," "am" "done")
```

This time, however, the extra leading space of the second line of "data.txt" has disappeared in the result. The space is considered a part of the separator that surrounds the word "good".

- ```
(read-words/line f) → (listof (listof string?))
f : (or/c 'standard-in 'stdin (and/c string? file-exists?))
```

reads the standard input device (until closed) or the content of file *f* and produces it as a list of lists, one per line; each line is represented as a list of strings.

Example:

```
> (read-words/line "data.txt")
'(("hello" "world") ("good" "bye") () ("i," "for" "1," "am"
"done"))
```

The results is similar to the one that `read-words` produces,

except that the organization of the file into lines is preserved. In particular, the empty third line is represented as an empty list of words.

If the last line is not terminated by a newline, the functions acts as if there were one.

- ```
(read-words-and-numbers/line f) → (listof (or number? string?))  
  f : (or/c 'standard-in 'stdin (and/c string? file-exists?))
```

reads the standard input device (until closed) or the content of file `f` and produces it as a list of lists, one per line; each line is represented as a list of strings and numbers.

Example:

```
> (read-words-and-numbers/line "data.txt")  
'(("hello" "world") ("good" "bye") () ("i," "for" "1," "am"  
"done"))
```

The results is like the one that `read-words/line` produces, except strings that can be parsed as numbers are represented as numbers.

If the last line is not terminated by a newline, the functions acts as if there were one.

- ```
(read-csv-file f) → (listof (listof any/c))
 f : (or/c 'standard-in 'stdin (and/c string? file-exists?))
```

reads the standard input device (until closed) or the content of file `f` and produces it as a list of lists of comma-separated values.

Example:

```
> (read-csv-file "data.csv")
'(("hello" "world") ("good" "bye") ("i" "am" "done"))
```

where the file named `"data.csv"` has this shape:

```
hello, world
good, bye
i, am, done
```

It is important to understand that the rows don't have to have the same length. Here the third line of the file turns into a row of three elements.

- ```
(read-csv-file/rows f s) → (listof X?)  
  f : (or/c 'standard-in 'stdin (and/c string? file-exists?))  
  s : (-> (listof any/c) X?)
```

reads the standard input device (until closed) or the content of file *f* and produces it as reads the content of file *f* and produces it as list of rows, each constructed via *s*.

Examples:

```
> (read-csv-file/rows "data.csv" (lambda (x) x))
'(("hello" "world") ("good" "bye") ("i" "am" "done"))
> (read-csv-file/rows "data.csv" length)
'(2 2 3)
```

The first example shows how `read-csv-file` is just a short form for `read-csv-file/rows`; the second one simply counts the number of separated tokens and the result is just a list of numbers. In many cases, the function argument is used to construct a structure from a row.

- ```
(read-xexpr f) → xexpr?
 f : (or/c 'standard-in 'stdin (and/c string? file-exists?))
```

reads the standard input device (until closed) or the content of file *f* and produces it as an X-expression, including whitespace such as tabs and newlines.

Assumption: the file *f* or the selected input device contains an XML element. It assumes the file contains HTML-like text and reads it as XML.

Example:

```
> (read-xexpr "data.xml")
'(pre () "\nhello world\ngood bye\n\ni, for 1, am done\n")
```

assuming the file named "data.xml" has this shape:

```
<pre>
hello world
good bye

i, for 1, am done
</pre>
```

Note how the result includes "\\n" for the newlines.

- ```
(read-plain-xexpr f) → xexpr?
  f : (or/c 'standard-in 'stdin (and/c string? file-exists?))
```

reads the standard input device (until closed) or the content of file *f* and produces it as an X-expression, without whitespace.

Assumption: the file *f* or the selected input device contains an XML element and the content of this element are other XML elements and whitespace. In particular, the XML element does not contain any strings as elements other than whitespace.

Example:

```
> (read-plain-xexpr "data-plain.xml")
'(pre
  ()
  (line ((text "hello world")))
  (line ((text "good bye")))
  (line ())
  (line ((text "i, for 1, am done"))))
```

assuming the file named "data-plain.xml" has this shape:

```
<pre>
<line text="hello world" />
<line text="good bye" />
<line />
<line text="i, for 1, am done" />
</pre>
```

Compare this result with the one for `read-xexpr`.

There is only one writer function at the moment:

- ```
(write-file f cntnt) → string?
 f : (or/c 'standard-out 'stdout string?)
 cntnt : string?
```

sends `cntnt` to the standard output device or turns `cntnt` into the content of file `f`, located in the same folder (directory) as the program. If the write succeeds, the function produces the name of the file (`f`); otherwise it signals an error.

Example:

```
> (if (string=? (write-file "output.txt" "good
 bye") "output.txt")
 (write-file "output.txt" "cruel world")
 (write-file "output.txt" "cruel world"))
"output.txt"
```

After evaluating this examples, the file named "output.txt" looks like this: cruel world Explain why.

- ```
(file-exists? f) → boolean?
  f : string?
```

determines whether a file with the given name exists in the current directory.

Warning: The file IO functions in this teachpack are platform dependent. That is, as long as your programs and your files live on the same platform, you should not have any problems reading the files that programs wrote and vice versa. If, however, one of your programs writes a file on a Windows operating system and if you then copy this output file to a Mac, reading the copied text file may produce extraneous “return” characters. Note that this describes only one example of possible malfunction; there are other cases when trans-platform actions may cause this teachpack to fail.

2.1.2 Web Functions

All functions that read a web-based XML consume a URL and possibly additional arguments. They assume that the computer is connected to specified part of the web, though they tolerate non-existent web pages (404 errors)

- ```
(read-xexpr/web u) → xexpr?
u : string?
```

reads the content of URL *u* and produces the first XML element as an `xexpr?` including whitespace such as tabs and newlines. If possible, the function interprets the HTML at the specified URL as XML. The function returns `#f` if the web page does not exist (404)

- ```
(read-plain-xexpr/web u) → xexpr?  
u : string?
```

reads the content of URL *u* and produces the first XML element as an `xexpr?` without whitespace. If possible, the function interprets the HTML at the specified URL as XML. The function returns `#f` if the web page does not exist (404)

- ```
(url-exists? u) → boolean?
u : string?
```

ensures that the specified URL *u* does not produce a 404 error.

- ```
(xexpr? u) → boolean?  
u : any?
```

checks that the given value is an X-expression in the following sense:

```

; Xexpr is one of:
; - symbol?
; - string?
; - number?
; - (cons symbol? (cons [List-of Attribute] [List-of Xexpr]))
; - (cons symbol? [List-of Xexpr])
;
; Attribute is:
;   (list symbol? string?)
; (list 'a "some text") is called an a-Attribute
; and "some text" is a's value.

```

Note that full Racket uses a wider notion of X-expression.

- `(xexpr-as-string x) → string?`
`x : xexpr?`

renders the given X-expression as a string.

- `(url-html-neighbors u) → (listof string?)`
`u : string?`

retrieves the content of URL `u` and produces the list of all URLs that refer to .html pages via an `<a>` tag.

2.1.3 Testing

```
(simulate-file process str ...)
```

simulates a file system for the function `process`, which reads a file and may produce one. Note: this form is under development and will be documented in a precise manner after it is finalized and useful for a wide audience.

2.2 Image Guide

This section introduces the `2htdp/image` library through a series of increasingly complex image constructions and discusses some subtle details of cropping and outline images.

2.2.1 Overlaying, Above, and Beside: A House

To build a simple-looking house, we can place a triangle above a rectangle.

```
> (above (triangle 40 "solid" "red")
         (rectangle 40 30 "solid" "black"))
```



We can give the house two roofs by putting two triangles next to each other.

```
> (above (beside (triangle 40 "solid" "red")
                (triangle 40 "solid" "red"))
         (rectangle 80 40 "solid" "black"))
```

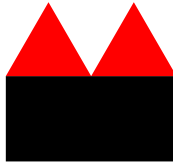

But if we want the new roof to be a little smaller, then they do not line up properly.

```
> (above (beside (triangle 40 "solid" "red")
                (triangle 30 "solid" "red"))
         (rectangle 70 40 "solid" "black"))
```

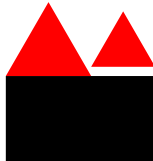

Instead, we can use `beside/align` to line up the two triangles along their bottoms instead of along the middles (which is what `beside` does).

```
> (define victorian
  (above (beside/align "bottom"
                    (triangle 40 "solid" "red")
                    (triangle 30 "solid" "red"))
        (rectangle 70 40 "solid" "black")))
> victorian
```

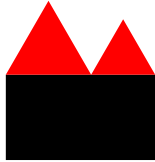

To add a door to the house, we can overlay a brown `rectangle`, aligning it with the center bottom of the rest of the house.

```
> (define door (rectangle 15 25 "solid" "brown"))  
> (overlay/align "center" "bottom" door victorian)
```

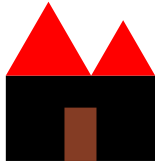

We can use a similar technique to put a doorknob on the door, but instead of overlaying the doorknob on the entire house, we can overlay it just on the door.

```
> (define door-with-knob  
  (overlay/align "right" "center" (circle 3 "solid" "yellow") door))  
> (overlay/align "center" "bottom" door-with-knob victorian)
```

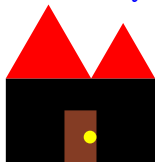

2.2.2 Rotating and Overlaying: A Rotary Phone Dial

A rotary phone dial can be built by from a black disk and 10 little white ones by placing the white disks, one at a time, at the top of the black disk and then rotating the entire black disk. To get started, lets define a function to make little white disks with numbers on them:

```
> (define (a-number digit)  
  (overlay  
    (text (number->string digit) 12 "black")  
    (circle 10 "solid" "white")))
```

We'll use `place-and-turn` to put the numbers onto the disk:

```
> (define (place-and-turn digit dial)
  (rotate 30
    (overlay/align "center" "top"
      (a-number digit)
      dial)))
```

For example:

```
> (place-and-turn
  0
  (circle 60 "solid" "black"))
```

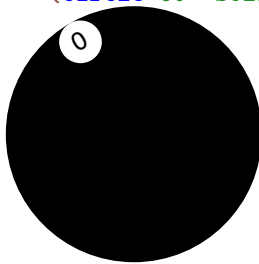

```
> (place-and-turn
  8
  (place-and-turn
  9
  (place-and-turn
  0
  (circle 60 "solid" "black")))))
```

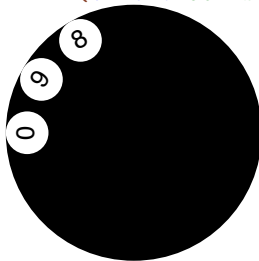

We can write a single function to put all of the numbers together into the dial:

```
> (define (place-all-numbers dial)
  (place-and-turn
  1
  (place-and-turn
  2
  (place-and-turn
```

```

3
(place-and-turn
4
(place-and-turn
5
(place-and-turn
6
(place-and-turn
7
(place-and-turn
8
(place-and-turn
9
(place-and-turn
0
dial))))))))))
> (place-all-numbers (circle 60 "solid" "black"))

```

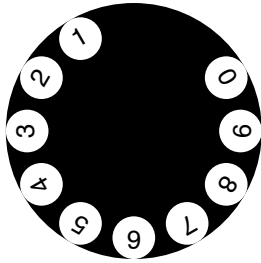

That definition is long and tedious to write. We can shorten it using `foldl`:

```

> (define (place-all-numbers dial)
  (foldl place-and-turn
    dial
    '(0 9 8 7 6 5 4 3 2 1)))
> (place-all-numbers (circle 60 "solid" "black"))

```

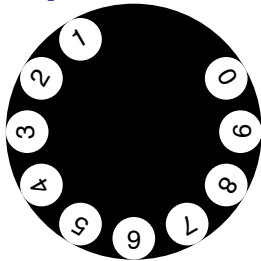

To finish off the dial, we need to rotate it a little bit to its natural position and put a white disk in the center of it. Here's the inner dial:

```
> (define inner-dial
  (overlay
    (text "555-1234" 9 "black")
    (circle 30 "solid" "white")))
```

and here's a function to build the entire rotary dial, with an argument that scales the dial:

```
> (define (rotary-dial f)
  (scale
    f
    (overlay
      inner-dial
      (rotate
        -90
        (place-all-numbers (circle 60 "solid" "black"))))))
> (rotary-dial 2)
```

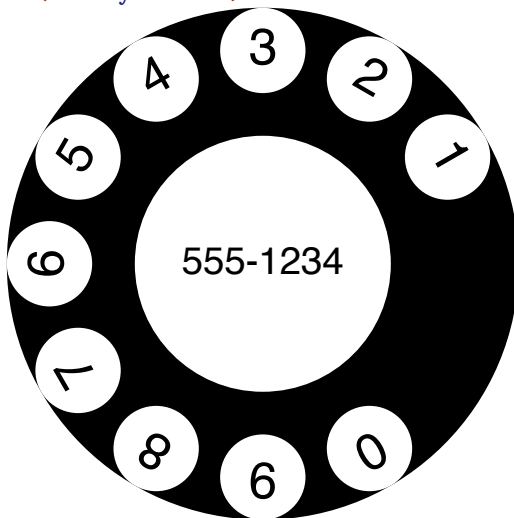

Looking at the image, it feels like the numbers are too close to the edge of the dial. So we can adjust the `place-and-turn` function to put a little black rectangle on top of each number. The rectangle is invisible because it ends up on top of the black dial, but it does serve to push the digits down a little.

```
> (define (place-and-turn digit dial)
  (rotate 30
    (overlay/align "center" "top"
      (above
        (rectangle 1 5 "solid" "black")
        (a-number digit))
      dial)))
```

```
> (rotary-dial 2)
```

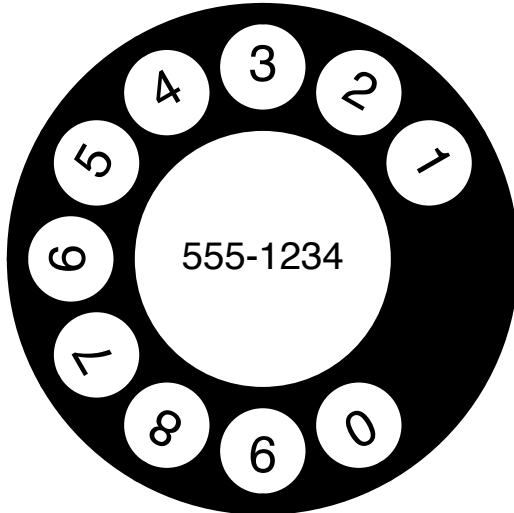

2.2.3 Alpha Blending

With shapes that have opaque colors like "red" and "blue", overlaying one on top completely blots out the one on the bottom.

For example, the green rectangle here completely covers the blue one where the two rectangles overlap.

```
> (overlay  
  (rectangle 60 100 "solid" (color 127 255 127))  
  (rectangle 100 60 "solid" (color 127 127 255)))
```

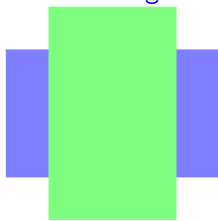

But `2htdp/image` also supports colors that are not completely opaque, via the (optional) fourth argument to `color`.

```
> (overlay  
  (rectangle 60 100 "solid" (color 0 255 0 127))  
  (rectangle 100 60 "solid" (color 0 0 255 127)))
```

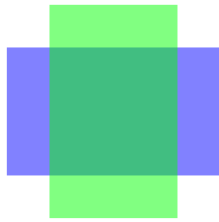

In this example, the color `(color 0 255 0 127)` looks just like the color `(color 127 255 127)` when the background is white. Since white is `(color 255 255 255)`, we end up getting $1/2$ of 255 for the red and blue components and 255 for the green one.

We can also use alpha blending to make some interesting effects. For example, the function `spin-alot` takes an image argument and repeatedly places it on top of itself, rotating it each time by 1 degree.

```
> (define (spin-alot t)
  (local [(define (spin-more i θ)
            (cond
              [(= θ 360) i]
              [else
               (spin-more (overlay i (rotate θ t))
                           (+ θ 1))]))])
    (spin-more t 0)))
```

Here are some uses of `spin-alot`, first showing the original shape and then the spun shape.

```
> (rectangle 12 120 "solid" (color 0 0 255))
```



```
> (spin-alot (rectangle 12 120 "solid" (color 0 0 255 1)))
```

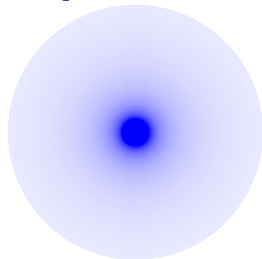

```
> (triangle 120 "solid" (color 0 0 255))
```

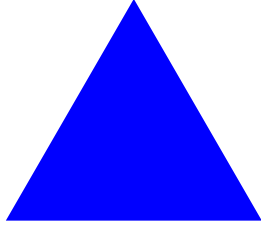

```
> (spin-alot (triangle 120 "solid" (color 0 0 255 1)))
```

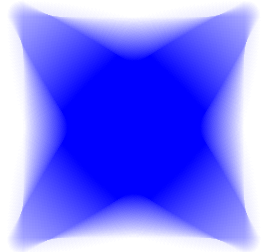

```
> (isosceles-triangle 120 30 "solid" (color 0 0 255))
```

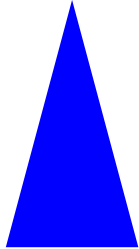

```
> (spin-alot (isosceles-triangle 120 30 "solid" (color 0 0 255 1)))
```

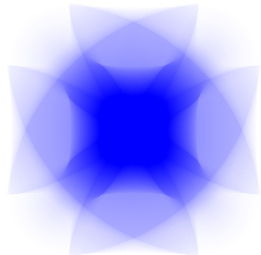

2.2.4 Recursive Image Functions

It is also possible to make interesting looking shapes with little recursive functions. For example, this function repeatedly puts white circles that grow, evenly spaced around the edge of the given shape:

```
> (define (swoosh image s)  
  (cond
```

```

    [(zero? s) image]
    [else (swoosh
           (overlay/align "center" "top"
                         (circle (* s 1/2) "solid" "white")
                         (rotate 4 image))
           (- s 1)))]))

```

```

> (swoosh (circle 100 "solid" "black")
          94)

```

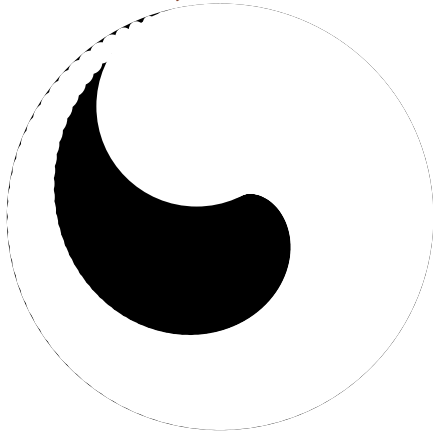

More conventional fractal shapes can also be written using the image library, e.g.:

```

> (define (sierpinski-carpet n)
  (cond
    [(zero? n) (square 1 "solid" "black")]
    [else
     (local [(define c (sierpinski-carpet (- n 1)))]
       (define i (square (image-width c) "solid" "white"))
       (above (beside c c c)
               (beside c i c)
               (beside c c c))))]))

> (sierpinski-carpet 5)

```

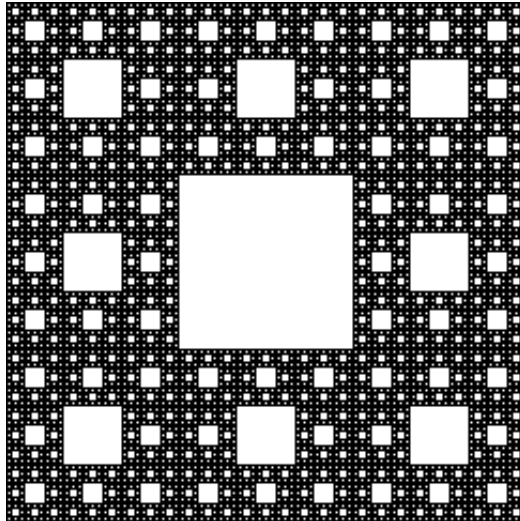

We can adjust the carpet to add a little color:

```
> (define (colored-carpet colors)
  (cond
    [(empty? (rest colors))
     (square 1 "solid" (first colors))]
    [else
     (local [(define c (colored-carpet (rest colors)))
              (define i (square (image-width c) "solid" (car colors)))]
       (above (beside c c c)
               (beside c i c)
               (beside c c c))))])

> (colored-carpet
  (list (color 51 0 255)
        (color 102 0 255)
        (color 153 0 255)
        (color 204 0 255)
        (color 255 0 255)
        (color 255 204 0)))
```

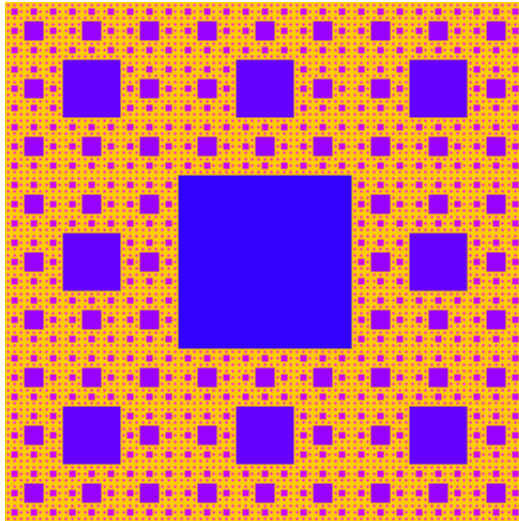

The Koch curve can be constructed by simply placing four curves next to each other, rotated appropriately:

```
> (define (koch-curve n)
  (cond
    [(zero? n) (square 1 "solid" "black")]
    [else
     (local [(define smaller (koch-curve (- n 1)))]
       (beside/align "bottom"
                     smaller
                     (rotate 60 smaller)
                     (rotate -60 smaller)
                     smaller))))])
> (koch-curve 5)
```

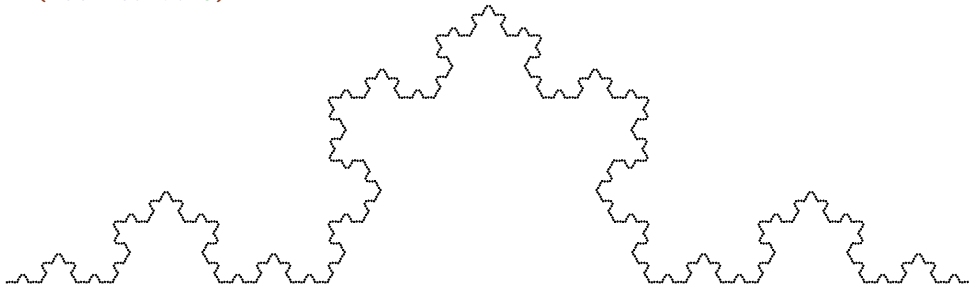

And then put three of them together to form the Koch snowflake.

```
> (above
  (beside
```

```
(rotate 60 (koch-curve 5))  
(rotate -60 (koch-curve 5))  
(flip-vertical (koch-curve 5))
```

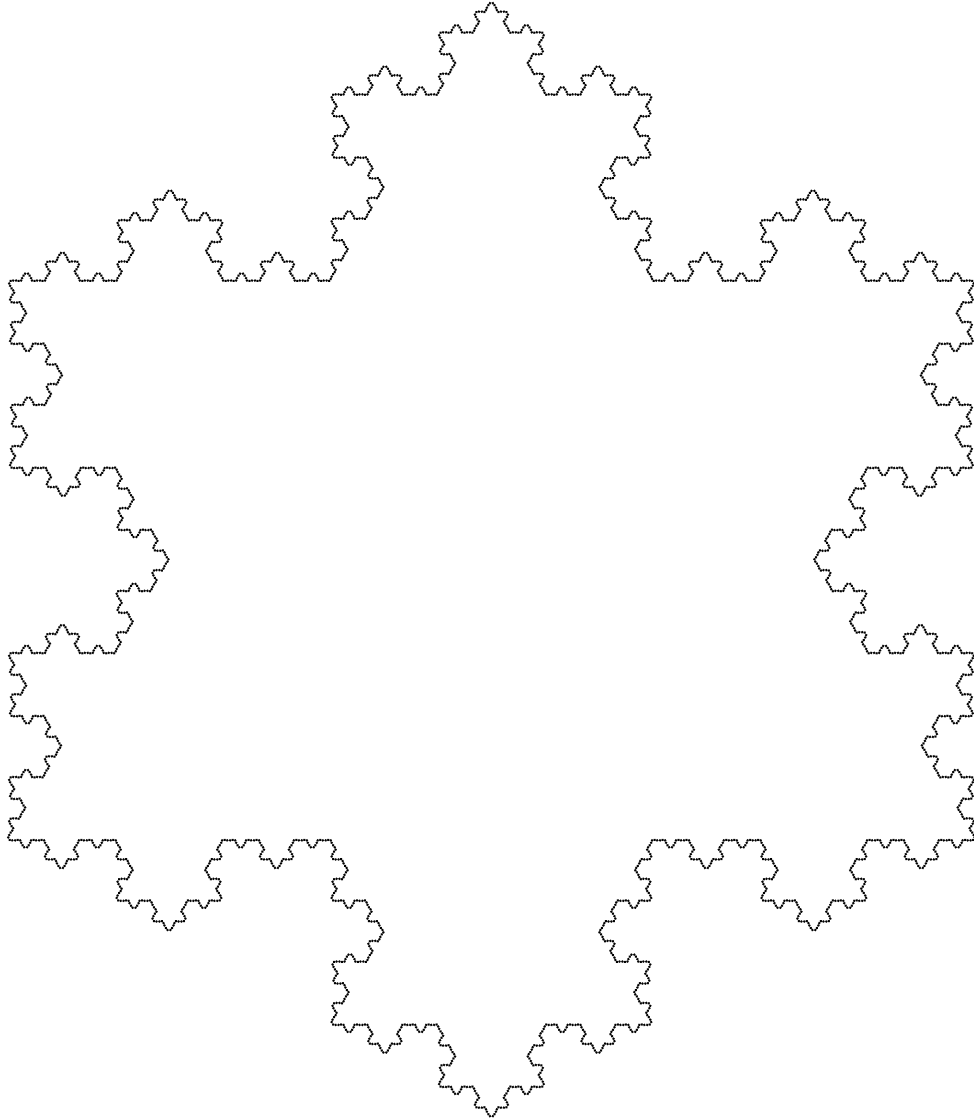

2.2.5 Rotating and Image Centers

When rotating an image, some times the image looks best when it rotates around a point that is not the center of the image. The `rotate` function, however, just rotates the image as a whole, effectively rotating it around the center of its bounding box.

For example, imagine a game where the hero is represented as a triangle:

```
> (define (hero  $\alpha$ )
  (triangle 30 "solid" (color 255 0 0  $\alpha$ )))
> (hero 255)
```



rotating the hero at the prompt looks reasonable:

```
> (rotate 10 (hero 255))
```



```
> (rotate 20 (hero 255))
```



```
> (rotate 30 (hero 255))
```



but if the hero has to appear to spin in place, then it will not look right, as you can kind of see if we use α -blending to represent old positions of the hero:

```
> (overlay (rotate 0 (hero 255))
  (rotate 10 (hero 125))
  (rotate 20 (hero 100))
  (rotate 30 (hero 75))
  (rotate 40 (hero 50))
  (rotate 50 (hero 25)))
```



What we'd really want is for the hero to appear to rotate around the centroid of the triangle. To achieve this effect, we can put the hero onto a transparent circle such that the center of the whole image lines up with the centroid of the triangle:

```
> (define (hero-on-blank  $\alpha$ )
  (define the-hero (hero  $\alpha$ ))
  (define w (image-width the-hero))
  (define h (image-height the-hero))
  (define d (max w h))
  (define dx (/ w 2)) ; centroid x offset
  (define dy (* 2/3 h)) ; centroid y offset
  (define blank (circle d "solid" (color 255 255 255 0)))
  (place-image/align the-hero (- d dx) (- d dy) "left" "top" blank))
```

and now the rotating hero looks reasonable:

```
> (overlay (rotate 0 (hero-on-blank 255))
           (rotate 10 (hero-on-blank 125))
           (rotate 20 (hero-on-blank 100))
           (rotate 30 (hero-on-blank 75))
           (rotate 40 (hero-on-blank 50))
           (rotate 50 (hero-on-blank 25)))
```



2.2.6 Image Interoperability

Images can connect to other libraries. Specifically:

- images are `snip%` objects, so can be inserted into `text%` and `pasteboard%` objects
- they implement the `convert` protocol for `'png-bytes`
- they implement the `pict-convert` protocol, and
- there is a low-level interface for drawing directly into a `dc< %>` object: `render-image`.

2.2.7 The Nitty Gritty of Pixels, Pens, and Lines

The image library treats coordinates as if they are in the upper-left corner of each pixel, and infinitesimally small (unlike pixels, which have some area).

Thus, when drawing a solid `square` of whose side-length is 10, the image library colors in all of the pixels enclosed by the `square` starting at the upper left corner of (0,0) and going down to the upper left corner of (10,10), so the pixel whose upper left at (9,9) is colored in, but the pixel at (10,10) is not. All told, 100 pixels get colored in, just as expected for a `square` with a side length of 10.

When drawing lines, however, things get a bit more complex. Specifically, imagine drawing the outline of that rectangle. Since the border is between the pixels, there really isn't a natural pixel to draw to indicate the border. Accordingly, when drawing an outline `square` (without a `pen` specification, but just a color as the last argument), the image library uses a pen whose width is 1 pixel, but draws a line centered at the point (0.5,0.5) that goes down and around to the point (10.5,10.5). This means that the outline slightly exceeds the bounding box of the

shape. Specifically, the upper and left-hand lines around the square are within the bounding box, but the lower and right-hand lines are just outside.

This kind of rectangle is useful when putting rectangles next to each other and avoiding extra thick lines on the interior. For example, consider building a grid like this:

```
> (define s1 (square 20 'outline 'black))
> (define r1 (beside s1 s1 s1 s1 s1 s1))
> (above r1 r1 r1 r1 r1 r1)
```

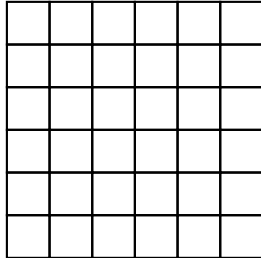

The reason interior lines in this grid are the same thickness as the lines around the edge is because the rectangles overlap with each other. That is, the upper-left rectangle's right edge is right on top of the next rectangle's left edge.

The special case of adding 0.5 to each coordinate when drawing the square applies to all outline polygon-based shapes that just pass color, but does not apply when a `pen` is passed as the last argument to create the shape. For example, if using a pen of thickness 2 to draw a rectangle, we get a shape that has a border drawing the row of pixels just inside and just outside the shape. One might imagine that a pen of thickness 1 would draw an outline around the shape with a 1 pixel thick line, but this would require 1/2 of each pixel to be illuminated, something that is not possible. Instead, the same pixels are lit up as with the 2 pixel wide pen, but with only 1/2 of the intensity of the color. So a 1 pixel wide black `pen` object draws a 2 pixel wide outline, but in gray.

```
> (define p1 (make-pen "black" 1 "solid" "round" "round"))
> (rectangle 20 20 "outline" p1)
```



When combining pens and cropping, we can make a rectangle that has a line that is one pixel wide, but where the line is drawn entirely within the rectangle. This rectangle has a two-pixel wide black pen, but we can crop out the outer portion of the pen.

```
> (define p2 (make-pen "black" 2 "solid" "round" "round"))
> (define s2 (crop 0 0 20 20 (rectangle 20 20 "outline" p2)))
```

If you are reading along with this section using DrRacket, note that DrRacket clips images to their bounding boxes when rendering them in the interactions window; read on for the ramifications but know for now that what you see in the example results here will not be exactly the same as what you see in the interactions window for that reason.

```
> s2
```



Using that we can build a grid now too, but this grid has doubled lines on the interior.

```
> (define r2 (beside s2 s2 s2 s2 s2 s2))
> (above r2 r2 r2 r2 r2 r2)
```

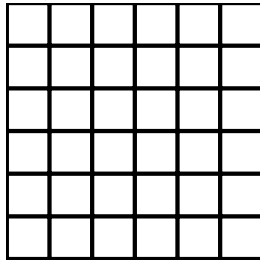

While this kind of rectangle is not useful for building grids, it is important to be able to build rectangles whose drawing does not exceed its bounding box. Specifically, this kind of drawing is used by `frame` and `empty-scene` so that the extra drawn pixels are not lost if the image is later clipped to its bounding box.

When using `image->color-list` with outline shapes, the results can be surprising for the same reasons. For example, a 2x2 black, outline rectangle consists of nine black pixels, as discussed above, but since `image->color-list` only returns the pixels that are within the bounding box, we see only three black pixels and one white one.

```
> (image->color-list
  (rectangle 2 2 "outline" "black"))
(list
 (color 0 0 0 255)
 (color 0 0 0 255)
 (color 0 0 0 255)
 (color 255 255 255 0))
```

The black pixels are (most of) the upper and left edge of the outline shape, and the one white pixel is the pixel in the middle of the shape.

2.2.8 The Nitty Gritty of Alpha Blending

Alpha blending can cause imprecision in color comparisons resulting in shapes that appear `equal?` even though they were created with different colors. This section explains how that happens.

To start, consider the color `(make-color 1 1 1 50)`. This color is nearly the darkest shade of black, but with lots of transparency, so it renders a light gray color on a white background, e.g.:

```
> (rectangle 100 100 "solid" (make-color 1 1 1 50))
```



If the background had been green, the same rectangle would look like a darker shade of green:

```
> (overlay
  (rectangle 100 100 "solid" (make-color 1 1 1 50))
  (rectangle 200 200 "solid" "green"))
```

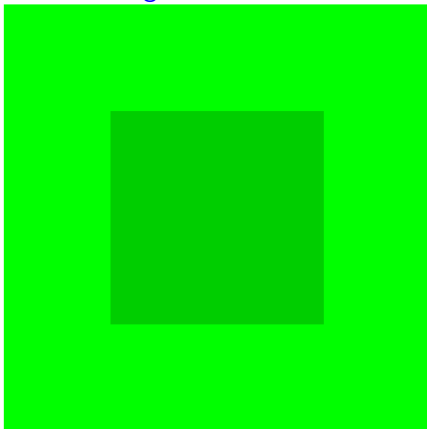

Surprisingly, this shape is equal to one that (apparently) has a different color in it:

```
> (equal?
  (rectangle 100 100 'solid (make-color 1 1 1 50))
  (rectangle 100 100 'solid (make-color 2 2 2 50)))
#t
```

To understand why, we must look more carefully at how alpha blending and image equality work. Image equality's definition is straightforward: two images are equal if they are both drawn the same. That is, image equality is defined by simply drawing the two shapes on a white background and then comparing all of the pixels for the two drawings (it is implemented more efficiently in some cases, however).

So, for those shapes to be equal, they must be drawn with the same colors. To see what colors were actually drawn, we can use `image->color-list`. Since these images use the same color in every pixel, we can examine just the first one:

```
> (first
  (image->color-list
   (rectangle 100 100 'solid (make-color 1 1 1 50))))
(color 0 0 0 50)
> (first
  (image->color-list
   (rectangle 100 100 'solid (make-color 2 2 2 50))))
(color 0 0 0 50)
```

As expected from the `equal?` test, the two colors are the same, but why should they be the same? This is where a subtle aspect of alpha blending and drawing comes up. In general, alpha blending works by taking the color of any shapes below the one being drawn and then combining that color with the new color. The precise amount of the combination is controlled by the alpha value. So, if a shape has an alpha value of α , then the drawing library multiplies the new shapes color by $(/ \alpha 255)$ and the existing shape's color by $(- 1 (/ \alpha 255))$ and then adds the results to get the final color. (It does this for each of the red, green, and blue components separately.)

Going back to the two example rectangles, the drawing library multiplies `50/255` by `1` for the first shape and multiplies `50/255` by `2` for the second shape (since they are both drawn on a white background). Then it rounds them to integers, which results in `0` for both colors, making the images the same.

2.3 Images: "image.rkt"

```
(require 2htdp/image)    package: htdp-lib
```

The image teachpack provides a number of basic image construction functions, along with combinators for building more complex images out of existing images. Basic images include various polygons, ellipses and circles, and text, as well as bitmaps. Existing images can be rotated, scaled, flipped, and overlaid on top of each other.

In some situations images are rendered into bitmaps (e.g. when being shown in the DrRacket Interactions window). In order to avoid bad performance penalties, the rendering process limits the area of the images to about 25,000,000 pixels (which requires about 100 MB of storage).

2.3.1 Basic Images

In the context of this documentation, a *bitmap* denotes a special form of `image?`, namely a collection of pixels associated with an image. It does not refer to the `bitmap%` class. Typically such image-bitmaps come about via the Insert Image... menu item in DrRacket

```

(circle radius mode color) → image?
  radius : (and/c real? (not/c negative?))
  mode : mode?
  color : image-color?
(circle radius outline-mode pen-or-color) → image?
  radius : (and/c real? (not/c negative?))
  outline-mode : (or/c 'outline "outline")
  pen-or-color : (or/c pen? image-color?)

```

Constructs a circle with the given radius, mode, and color.

Note that when the `mode` is `'outline` or `"outline"`, the shape may draw outside of its bounding box and thus parts of the image may disappear when it is cropped. See §2.2.7 “The Nitty Gritty of Pixels, Pens, and Lines” (in the §2.2 “Image Guide”) for a more careful explanation of the ramifications of this fact.

If the `mode` argument is `'outline` or `"outline"`, then the last argument can be a `pen` struct or an `image-color?`, but if the `mode` is `'solid` or `"solid"`, then the last argument must be an `image-color?`.

Examples:

```
> (circle 30 "outline" "red")
```

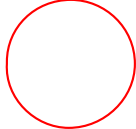

```
> (circle 20 "solid" "blue")
```



```
> (circle 20 100 "blue")
```



```

(ellipse width height mode color) → image?
  width : (and/c real? (not/c negative?))
  height : (and/c real? (not/c negative?))
  mode : mode?
  color : image-color?
(ellipse width height mode pen-or-color) → image?
  width : (and/c real? (not/c negative?))
  height : (and/c real? (not/c negative?))
  mode : (or/c 'outline "outline")
  pen-or-color : (or/c image-color? pen?)

```

Constructs an ellipse with the given width, height, mode, and color.

Note that when the `mode` is `'outline` or `"outline"`, the shape may draw outside of its bounding box and thus parts of the image may disappear when it is cropped. See §2.2.7 “The Nitty Gritty of Pixels, Pens, and Lines” (in the §2.2 “Image Guide”) for a more careful explanation of the ramifications of this fact.

If the `mode` argument is `'outline` or `"outline"`, then the last argument can be a `pen` struct or an `image-color?`, but if the `mode` is `'solid` or `"solid"`, then the last argument must be an `image-color?`.

Examples:

```
> (ellipse 60 30 "outline" "black")
```

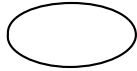

```
> (ellipse 30 60 "solid" "blue")
```



```
> (ellipse 30 60 100 "blue")
```



```
(wedge radius angle mode color) → image?  
  radius : (and/c real? positive?)  
  angle  : angle?  
  mode   : mode?  
  color  : image-color?  
(wedge radius angle mode pen-or-color) → image?  
  radius : (and/c real? positive?)  
  angle  : angle?  
  mode   : (or/c 'outline "outline")  
  pen-or-color : (or/c image-color? pen?)
```

Constructs a wedge of a circle with the given radius, angle, mode, and color. The angle must be between 0 and 360 (but not equal to either 0 or 360).

Note that when the `mode` is `'outline` or `"outline"`, the shape may draw outside of its bounding box and thus parts of the image may disappear when it is cropped. See §2.2.7 “The Nitty Gritty of Pixels, Pens, and Lines” (in the §2.2 “Image Guide”) for a more careful explanation of the ramifications of this fact.

If the *mode* argument is 'outline' or "outline", then the last argument can be a `pen` struct or an `image-color?`, but if the *mode* is 'solid' or "solid", then the last argument must be an `image-color?`.

Examples:

```
> (wedge 60 60 "outline" "purple")
```

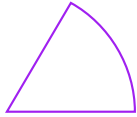

```
> (rotate 30 (wedge 30 300 "solid" "gold"))
```



```
(line x1 y1 pen-or-color) → image?  
x1 : real?  
y1 : real?  
pen-or-color : (or/c pen? image-color?)
```

Constructs an image representing a line segment that connects the points (0,0) to (x1,y1).

Examples:

```
> (line 30 30 "black")
```



```
> (line -30 20 "red")
```



```
> (line 30 -20 "red")
```



```
(add-line image x1 y1 x2 y2 pen-or-color) → image?  
image : image?  
x1 : real?  
y1 : real?  
x2 : real?  
y2 : real?  
pen-or-color : (or/c pen? image-color?)
```

Adds a line to the image *image*, starting from the point (x1,y1) and going to the point (x2,y2). Unlike `scene+line`, if the line passes outside of *image*, the image gets larger to accommodate the line.

Examples:

```
> (add-line (ellipse 40 40 "outline" "maroon")
            0 40 40 0 "maroon")
```



```
> (add-line (rectangle 40 40 "solid" "gray")
            -10 50 50 -10 "maroon")
```



```
> (add-line
    (rectangle 100 100 "solid" "darkolivegreen")
    25 25 75 75
    (make-pen "goldenrod" 30 "solid" "round" "round"))
```



```
(add-curve image
  x1
  y1
  angle1
  pull1
  x2
  y2
  angle2
  pull2
  pen-or-color) → image?
image : image?
x1 : real?
y1 : real?
angle1 : angle?
pull1 : real?
x2 : real?
y2 : real?
angle2 : angle?
pull2 : real?
pen-or-color : (or/c pen? image-color?)
```

Adds a curve to *image*, starting at the point (*x1,y1*), and ending at the point (*x2,y2*).

The *angle1* and *angle2* arguments specify the angle that the curve has as it leaves the initial point and as it reaches the final point, respectively.

The *pull1* and *pull2* arguments control how long the curve tries to stay with that angle. Larger numbers mean that the curve stays with the angle longer.

Unlike *scene+curve*, if the line passes outside of *image*, the image gets larger to accommodate the curve.

Examples:

```
> (add-curve (rectangle 100 100 "solid" "black")
             20 20 0 1/3
             80 80 0 1/3
             "white")
```

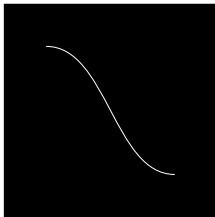

```
> (add-curve (rectangle 100 100 "solid" "black")
             20 20 0 1
             80 80 0 1
             "white")
```

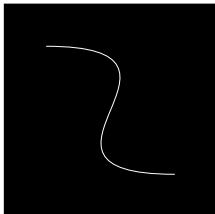

```
> (add-curve
  (add-curve
    (rectangle 40 100 "solid" "black")
    20 10 180 1/2
    20 90 180 1/2
    (make-pen "white" 4 "solid" "round" "round"))
  20 10 0 1/2
  20 90 0 1/2
  (make-pen "white" 4 "solid" "round" "round"))
```



```
> (add-curve (rectangle 100 100 "solid" "black")  
            -20 -20 0 1  
            120 120 0 1  
            "red")
```

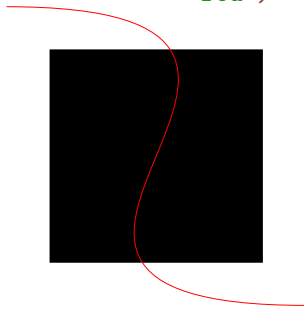

```
(add-solid-curve image  
                x1  
                y1  
                angle1  
                pull1  
                x2  
                y2  
                angle2  
                pull2  
                color) → image?  
  
image : image?  
x1 : real?  
y1 : real?  
angle1 : angle?  
pull1 : real?  
x2 : real?  
y2 : real?  
angle2 : angle?  
pull2 : real?  
color : image-color?
```

Adds a curve to *image* like `add-curve`, except it fills in the region inside the curve.

Examples:

```
> (add-solid-curve (rectangle 100 100 "solid" "black")
                   20 20 0 1
                   80 80 0 1
                   "white")
```

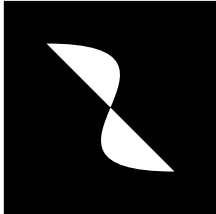

```
> (add-solid-curve
  (add-solid-curve
    (rectangle 100 100 "solid" "black")
    50 20 180 1/10
    50 80 0 1
    "white")
  50 20 0 1/10
  50 80 180 1
  "white")
```

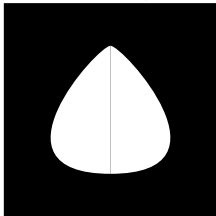

```
> (add-solid-curve
  (add-solid-curve
    (rectangle 100 100 "solid" "black")
    51 20 180 1/10
    50 80 0 1
    "white")
  49 20 0 1/10
  50 80 180 1
  "white")
```

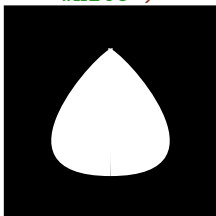

```
> (add-solid-curve (rectangle 100 100 "solid" "black")
                   -20 -20 0 1
                   120 120 0 1)
```

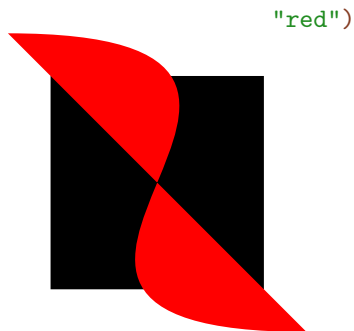

Added in version 1.2 of package `htdp-lib`.

```
(text string font-size color) → image?  
  string : string?  
  font-size : (and/c integer? (<=/c 1 255))  
  color : image-color?
```

Constructs an image that draws the given string, using the font size and color.

Examples:

```
> (text "Hello" 24 "olive")  
Hello  
> (text "Goodbye" 36 "indigo")  
Goodbye
```

If the string contains newlines, the result image will have multiple lines.

Example:

```
> (text "Hello and\nGoodbye" 24 "orange")  
Hello and  
Goodbye
```

The text size is measured in pixels, not points, so passing `24` to `text` should result in an image whose height is `24` (which might not be the case if the size were measured in points).

Example:

```
> (image-height (text "Hello" 24 "olive"))
24
```

Changed in version 1.7 of package `htdp-lib`: When called with strings that have newlines, `text` returns multiple-line images.

```
(text/font string
  font-size
  color
  face
  family
  style
  weight
  underline?) → image?
string : string?
font-size : (and/c integer? (<=/c 1 255))
color : image-color?
face : (or/c string? #f)
family : (or/c "default" "decorative" "roman" "script"
  "swiss" "modern" "symbol" "system"
  'default 'decorative 'roman 'script
  'swiss 'modern 'symbol 'system)
style : (or/c "normal" "italic" "slant"
  'normal 'italic 'slant)
weight : (or/c "normal" "bold" "light"
  'normal 'bold 'light)
underline? : any/c
```

Constructs an image that draws the given string, using a complete font specification.

The *face* and the *family* combine to give the complete typeface. If *face* is available on the system, it is used, but if not then a default typeface based on the *family* is chosen. The *style* controls if the face is italic or not (on Windows and Mac OS, `'slant` and `'italic` are the same), the *weight* controls if it is boldface (or light), and *underline?* determines if the face is underlined. For more details on these arguments, see `font%`, which ultimately is what this code uses to draw the font.

Examples:

```
> (text/font "Hello" 24 "olive"
  "Gill Sans" 'swiss 'normal 'bold #f)
```

Hello

```
> (text/font "Goodbye" 18 "indigo"
  #f 'modern 'italic 'normal #f)
```

Goodbye

```
> (text/font "not really a link" 18 "blue"
      #f 'roman 'normal 'normal #t)
not really a link
```

`empty-image` : image?

The empty image. Its width and height are both zero and it does not draw at all.

Examples:

```
> (image-width empty-image)
0
> (equal? (above empty-image
                 (rectangle 10 10 "solid" "red"))
          (beside empty-image
                  (rectangle 10 10 "solid" "red")))
#t
```

Combining an image with `empty-image` produces the original image (as shown in the above example).

2.3.2 Polygons

```
(triangle side-length mode color) → image?
  side-length : (and/c real? (not/c negative?))
  mode : mode?
  color : image-color?
(triangle side-length
          outline-mode
          pen-or-color) → image?
  side-length : (and/c real? (not/c negative?))
  outline-mode : (or/c 'outline "outline")
  pen-or-color : (or/c pen? image-color?)
```

Constructs a upward-pointing equilateral triangle. The *side-length* argument determines the length of the side of the triangle.

Note that when the *mode* is `'outline` or `"outline"`, the shape may draw outside of its bounding box and thus parts of the image may disappear when it is cropped. See §2.2.7 “The Nitty Gritty of Pixels, Pens, and Lines” (in the §2.2 “Image Guide”) for a more careful explanation of the ramifications of this fact.

If the *mode* argument is 'outline or "outline", then the last argument can be a `pen` struct or an `image-color?`, but if the *mode* is 'solid or "solid", then the last argument must be an `image-color?`.

Example:

```
> (triangle 40 "solid" "tan")
```



```
(right-triangle side-length1
                side-length2
                mode
                color) → image?
side-length1 : (and/c real? (not/c negative?))
side-length2 : (and/c real? (not/c negative?))
mode : mode?
color : image-color?
(right-triangle side-length1
                side-length2
                outline-mode
                pen-or-color) → image?
side-length1 : (and/c real? (not/c negative?))
side-length2 : (and/c real? (not/c negative?))
outline-mode : (or/c 'outline "outline")
pen-or-color : (or/c pen? image-color?)
```

Constructs a triangle with a right angle where the two sides adjacent to the right angle have lengths *side-length1* and *side-length2*.

Note that when the *mode* is 'outline or "outline", the shape may draw outside of its bounding box and thus parts of the image may disappear when it is cropped. See §2.2.7 “The Nitty Gritty of Pixels, Pens, and Lines” (in the §2.2 “Image Guide”) for a more careful explanation of the ramifications of this fact.

If the *mode* argument is 'outline or "outline", then the last argument can be a `pen` struct or an `image-color?`, but if the *mode* is 'solid or "solid", then the last argument must be an `image-color?`.

Example:

```
> (right-triangle 36 48 "solid" "black")
```



```

(isosceles-triangle side-length
                    angle
                    mode
                    color) → image?
side-length : (and/c real? (not/c negative?))
angle : angle?
mode : mode?
color : image-color?
(isosceles-triangle side-length
                    angle
                    outline-mode
                    pen-or-color) → image?
side-length : (and/c real? (not/c negative?))
angle : angle?
outline-mode : (or/c 'outline "outline")
pen-or-color : (or/c pen? image-color?)

```

Creates a triangle with two equal-length sides, of length *side-length* where the angle between those sides is *angle*. The third leg is straight, horizontally. If the angle is less than 180, then the triangle will point up and if the *angle* is more, then the triangle will point down.

Note that when the *mode* is 'outline or "outline", the shape may draw outside of its bounding box and thus parts of the image may disappear when it is cropped. See §2.2.7 “The Nitty Gritty of Pixels, Pens, and Lines” (in the §2.2 “Image Guide”) for a more careful explanation of the ramifications of this fact.

If the *mode* argument is 'outline or "outline", then the last argument can be a *pen* struct or an *image-color?*, but if the *mode* is 'solid or "solid", then the last argument must be an *image-color?*.

Examples:

```
> (isosceles-triangle 200 170 "solid" "seagreen")
```

```
> (isosceles-triangle 60 30 "solid" "aquamarine")
```

```
> (isosceles-triangle 60 330 "solid" "lightseagreen")
```

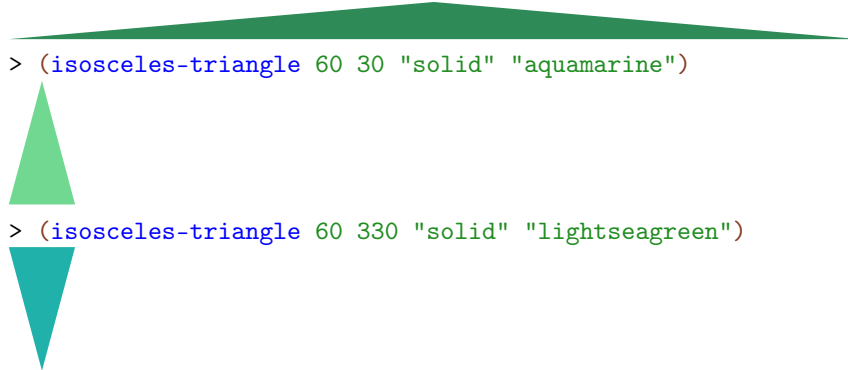

To create a triangle given known sides and angles, the following family of functions are useful:

- `triangle/sss`, if all three sides are known
- `triangle/ass`, `triangle/sas`, or `triangle/ssa`, if two sides and their included angle are known
- `triangle/aas`, `triangle/asa`, or `triangle/saa`, if two angles and their shared side are known.

They all construct a triangle oriented as follows:

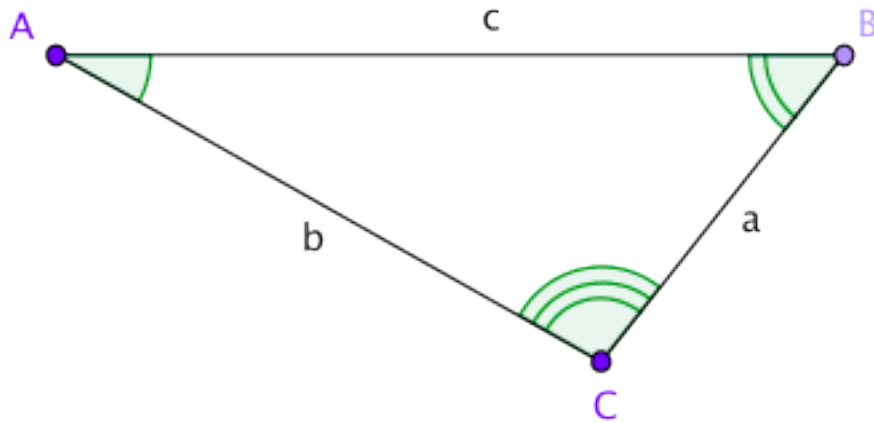

```
(triangle/sss side-length-a
              side-length-b
              side-length-c
              mode
              color) → image?
side-length-a : (and/c real? (not/c negative?))
side-length-b : (and/c real? (not/c negative?))
side-length-c : (and/c real? (not/c negative?))
mode : mode?
color : image-color?
(triangle/sss side-length-a
              side-length-b
              side-length-c
              outline-mode
              pen-or-color) → image?
side-length-a : (and/c real? (not/c negative?))
side-length-b : (and/c real? (not/c negative?))
```

```

side-length-c : (and/c real? (not/c negative?))
outline-mode : (or/c 'outline "outline")
pen-or-color : (or/c pen? image-color?)

```



Creates a triangle where the side lengths a, b, and, c are given by *side-length-a*, *side-length-b*, and, *side-length-c* respectively.

Note that when the *mode* is 'outline or "outline", the shape may draw outside of its bounding box and thus parts of the image may disappear when it is cropped. See §2.2.7 “The Nitty Gritty of Pixels, Pens, and Lines” (in the §2.2 “Image Guide”) for a more careful explanation of the ramifications of this fact.

If the *mode* argument is 'outline or "outline", then the last argument can be a *pen* struct or an *image-color?*, but if the *mode* is 'solid or "solid", then the last argument must be an *image-color?*.

Examples:

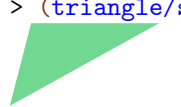
```

> (triangle/sss 40 60 80 "solid" "seagreen")

> (triangle/sss 80 40 60 "solid" "aquamarine")

> (triangle/sss 80 80 40 "solid" "lightseagreen")

```

```

(triangle/ass angle-a
              side-length-b
              side-length-c
              mode
              color)      → image?
angle-a : angle?
side-length-b : (and/c real? (not/c negative?))
side-length-c : (and/c real? (not/c negative?))
mode : mode?
color : image-color?

```

```
(triangle/ass angle-a
              side-length-b
              side-length-c
              outline-mode
              pen-or-color) → image?
angle-a : angle?
side-length-b : (and/c real? (not/c negative?))
side-length-c : (and/c real? (not/c negative?))
outline-mode : (or/c 'outline "outline")
pen-or-color : (or/c pen? image-color?)
```

Creates a triangle where the angle A and side length a and b, are given by *angle-a*, *side-length-b*, and, *side-length-c* respectively. See above for a diagram showing where which sides and which angles are which.

Note that when the *mode* is 'outline or "outline", the shape may draw outside of its bounding box and thus parts of the image may disappear when it is cropped. See §2.2.7 “The Nitty Gritty of Pixels, Pens, and Lines” (in the §2.2 “Image Guide”) for a more careful explanation of the ramifications of this fact.

If the *mode* argument is 'outline or "outline", then the last argument can be a *pen* struct or an *image-color?*, but if the *mode* is 'solid or "solid", then the last argument must be an *image-color?*.

Examples:

```
> (triangle/ass 10 60 100 "solid" "seagreen")
```

```
> (triangle/ass 90 60 100 "solid" "aquamarine")
```

```
> (triangle/ass 130 60 100 "solid" "lightseagreen")
```

```
(triangle/sas side-length-a
              angle-b
              side-length-c
              mode
              color) → image?
side-length-a : (and/c real? (not/c negative?))
angle-b : angle?
```

```

side-length-c : (and/c real? (not/c negative?))
mode : mode?
color : image-color?
(triangle/sas side-length-a
              angle-b
              side-length-c
              outline-mode
              pen-or-color) → image?
side-length-a : (and/c real? (not/c negative?))
angle-b : angle?
side-length-c : (and/c real? (not/c negative?))
outline-mode : (or/c 'outline "outline")
pen-or-color : (or/c pen? image-color?)

```

Creates a triangle where the side length a, angle B, and, side length c given by *side-length-a*, *angle-b*, and, *side-length-c* respectively. See above for a diagram showing where which sides and which angles are which.

Note that when the *mode* is 'outline or "outline", the shape may draw outside of its bounding box and thus parts of the image may disappear when it is cropped. See §2.2.7 “The Nitty Gritty of Pixels, Pens, and Lines” (in the §2.2 “Image Guide”) for a more careful explanation of the ramifications of this fact.

If the *mode* argument is 'outline or "outline", then the last argument can be a *pen* struct or an *image-color?*, but if the *mode* is 'solid or "solid", then the last argument must be an *image-color?*.

Examples:

```
> (triangle/sas 60 10 100 "solid" "seagreen")
```

```
> (triangle/sas 60 90 100 "solid" "aquamarine")
```

```
> (triangle/sas 60 130 100 "solid" "lightseagreen")
```

```

(triangle/ssa side-length-a
             side-length-b
             angle-c
             mode
             color) → image?

```

```

side-length-a : (and/c real? (not/c negative?))
side-length-b : (and/c real? (not/c negative?))
angle-c : angle?
mode : mode?
color : image-color?
(triangle/ssa side-length-a
              side-length-b
              angle-c
              outline-mode
              pen-or-color) → image?
side-length-a : (and/c real? (not/c negative?))
side-length-b : (and/c real? (not/c negative?))
angle-c : angle?
outline-mode : (or/c 'outline "outline")
pen-or-color : (or/c pen? image-color?)

```

Creates a triangle where the side length a, side length b, and, angle c given by *side-length-a*, *side-length-b*, and, *angle-c* respectively. See above for a diagram showing where which sides and which angles are which.

Note that when the *mode* is 'outline or "outline", the shape may draw outside of its bounding box and thus parts of the image may disappear when it is cropped. See §2.2.7 “The Nitty Gritty of Pixels, Pens, and Lines” (in the §2.2 “Image Guide”) for a more careful explanation of the ramifications of this fact.

If the *mode* argument is 'outline or "outline", then the last argument can be a *pen* struct or an *image-color?*, but if the *mode* is 'solid or "solid", then the last argument must be an *image-color?*.

Examples:

```
> (triangle/ssa 60 100 10 "solid" "seagreen")
```



```
> (triangle/ssa 60 100 90 "solid" "aquamarine")
```

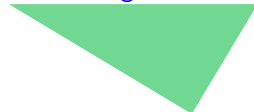

```
> (triangle/ssa 60 100 130 "solid" "lightseagreen")
```



```

(triangle/aas angle-a
              angle-b
              side-length-c
              mode
              color) → image?
angle-a : angle?
angle-b : angle?
side-length-c : (and/c real? (not/c negative?))
mode : mode?
color : image-color?
(triangle/aas angle-a
              angle-b
              side-length-c
              outline-mode
              pen-or-color) → image?
angle-a : angle?
angle-b : angle?
side-length-c : (and/c real? (not/c negative?))
outline-mode : (or/c 'outline "outline")
pen-or-color : (or/c pen? image-color?)

```

Creates a triangle where the angle A, angle B, and, side length c given by *angle-a*, *angle-b*, and, *side-length-c* respectively. See above for a diagram showing where which sides and which angles are which.

Note that when the *mode* is 'outline or "outline", the shape may draw outside of its bounding box and thus parts of the image may disappear when it is cropped. See §2.2.7 “The Nitty Gritty of Pixels, Pens, and Lines” (in the §2.2 “Image Guide”) for a more careful explanation of the ramifications of this fact.

If the *mode* argument is 'outline or "outline", then the last argument can be a *pen* struct or an *image-color?*, but if the *mode* is 'solid or "solid", then the last argument must be an *image-color?*.

Examples:

```
> (triangle/aas 10 40 200 "solid" "seagreen")
```



```
> (triangle/aas 90 40 200 "solid" "aquamarine")
```

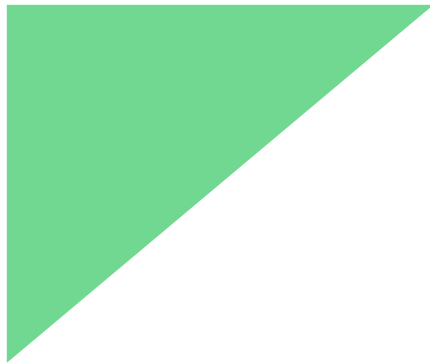

```
> (triangle/aas 130 40 40 "solid" "lightseagreen")
```



```
(triangle/asa angle-a
              side-length-b
              angle-c
              mode
              color) → image?
angle-a : angle?
side-length-b : (and/c real? (not/c negative?))
angle-c : angle?
mode : mode?
color : image-color?
(triangle/asa angle-a
              side-length-b
              angle-c
              outline-mode
              pen-or-color) → image?
angle-a : angle?
side-length-b : (and/c real? (not/c negative?))
angle-c : angle?
outline-mode : (or/c 'outline "outline")
pen-or-color : (or/c pen? image-color?)
```

Creates a triangle where the angle A, side length b, and, angle C given by *angle-a*, *side-length-b*, and, *angle-c* respectively. See above for a diagram showing where which sides and which angles are which.

Note that when the `mode` is `'outline` or `"outline"`, the shape may draw outside of its bounding box and thus parts of the image may disappear when it is cropped. See §2.2.7 “The Nitty Gritty of Pixels, Pens, and Lines” (in the §2.2 “Image Guide”) for a more careful explanation of the ramifications of this fact.

If the `mode` argument is `'outline` or `"outline"`, then the last argument can be a `pen` struct or an `image-color?`, but if the `mode` is `'solid` or `"solid"`, then the last argument must be an `image-color?`.

Examples:

```
> (triangle/asa 10 200 40 "solid" "seagreen")
```



```
> (triangle/asa 90 200 40 "solid" "aquamarine")
```

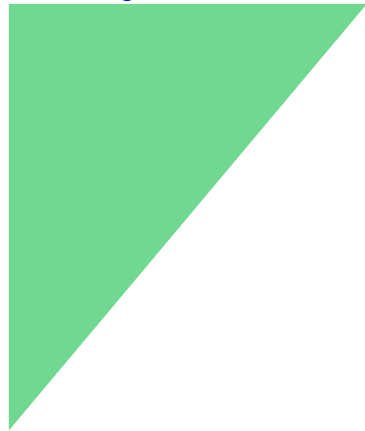

```
> (triangle/asa 130 40 40 "solid" "lightseagreen")
```



```
(triangle/saa side-length-a
              angle-b
              angle-c
              mode
              color) → image?
side-length-a : (and/c real? (not/c negative?))
angle-b      : angle?
angle-c      : angle?
mode         : mode?
color        : image-color?
```

```
(triangle/saa side-length-a
              angle-b
              angle-c
              outline-mode
              pen-or-color) → image?
side-length-a : (and/c real? (not/c negative?))
angle-b : angle?
angle-c : angle?
outline-mode : (or/c 'outline "outline")
pen-or-color : (or/c pen? image-color?)
```

Creates a triangle where the side length a, angle B, and, angle C given by *side-length-a*, *angle-b*, and, *angle-c* respectively. See above for a diagram showing where which sides and which angles are which.

Note that when the *mode* is 'outline or "outline", the shape may draw outside of its bounding box and thus parts of the image may disappear when it is cropped. See §2.2.7 “The Nitty Gritty of Pixels, Pens, and Lines” (in the §2.2 “Image Guide”) for a more careful explanation of the ramifications of this fact.

If the *mode* argument is 'outline or "outline", then the last argument can be a *pen* struct or an *image-color?*, but if the *mode* is 'solid or "solid", then the last argument must be an *image-color?*.

Examples:

```
> (triangle/saa 200 10 40 "solid" "seagreen")
```



```
> (triangle/saa 200 90 40 "solid" "aquamarine")
```



```
> (triangle/saa 40 130 40 "solid" "lightseagreen")
```





```
(square side-len mode color) → image?  
  side-len : (and/c real? (not/c negative?))  
  mode : mode?  
  color : image-color?  
(square side-len outline-mode pen-or-color) → image?  
  side-len : (and/c real? (not/c negative?))  
  outline-mode : (or/c 'outline "outline")  
  pen-or-color : (or/c pen? image-color?)
```

Constructs a square.

Note that when the *mode* is 'outline or "outline", the shape may draw outside of its bounding box and thus parts of the image may disappear when it is cropped. See §2.2.7 “The Nitty Gritty of Pixels, Pens, and Lines” (in the §2.2 “Image Guide”) for a more careful explanation of the ramifications of this fact.

If the *mode* argument is 'outline or "outline", then the last argument can be a [pen](#) struct or an [image-color?](#), but if the *mode* is 'solid or "solid", then the last argument must be an [image-color?](#).

Examples:

```
> (square 40 "solid" "slateblue")  
  
> (square 50 "outline" "darkmagenta")  

```

```
(rectangle width height mode color) → image?  
  width : (and/c real? (not/c negative?))  
  height : (and/c real? (not/c negative?))  
  mode : mode?  
  color : image-color?  
(rectangle width  
  height  
  outline-mode  
  pen-or-color) → image?  
  width : (and/c real? (not/c negative?))
```

```

height : (and/c real? (not/c negative?))
outline-mode : (or/c 'outline "outline")
pen-or-color : (or/c pen? image-color?)

```

Constructs a rectangle with the given width, height, mode, and color.

Note that when the `mode` is `'outline` or `"outline"`, the shape may draw outside of its bounding box and thus parts of the image may disappear when it is cropped. See §2.2.7 “The Nitty Gritty of Pixels, Pens, and Lines” (in the §2.2 “Image Guide”) for a more careful explanation of the ramifications of this fact.

If the `mode` argument is `'outline` or `"outline"`, then the last argument can be a `pen` struct or an `image-color?`, but if the `mode` is `'solid` or `"solid"`, then the last argument must be an `image-color?`.

Examples:

```
> (rectangle 40 20 "outline" "black")
```



```
> (rectangle 20 40 "solid" "blue")
```



```

(rhombus side-length angle mode color) → image?
  side-length : (and/c real? (not/c negative?))
  angle : angle?
  mode : mode?
  color : image-color?
(rhombus side-length
         angle
         outline-mode
         pen-or-color) → image?
  side-length : (and/c real? (not/c negative?))
  angle : angle?
  outline-mode : (or/c 'outline "outline")
  pen-or-color : (or/c pen? image-color?)

```

Constructs a four sided polygon with all equal sides and thus where opposite angles are equal to each other. The top and bottom pair of angles is `angle` and the left and right are `(- 180 angle)`.

Note that when the `mode` is `'outline` or `"outline"`, the shape may draw outside of its bounding box and thus parts of the image may disappear when it is cropped. See §2.2.7

“The Nitty Gritty of Pixels, Pens, and Lines” (in the §2.2 “Image Guide”) for a more careful explanation of the ramifications of this fact.

If the *mode* argument is 'outline or "outline", then the last argument can be a `pen` struct or an `image-color?`, but if the *mode* is 'solid or "solid", then the last argument must be an `image-color?`.

Examples:

```
> (rhombus 40 45 "solid" "magenta")
```



```
> (rhombus 80 150 "solid" "mediumpurple")
```



```
(star side-length mode color) → image?  
  side-length : (and/c real? (not/c negative?))  
  mode : mode?  
  color : image-color?  
(star side-length outline-mode color) → image?  
  side-length : (and/c real? (not/c negative?))  
  outline-mode : (or/c 'outline "outline")  
  color : (or/c pen? image-color?)
```

Constructs a star with five points. The *side-length* argument determines the side length of the enclosing pentagon.

Note that when the *mode* is 'outline or "outline", the shape may draw outside of its bounding box and thus parts of the image may disappear when it is cropped. See §2.2.7 “The Nitty Gritty of Pixels, Pens, and Lines” (in the §2.2 “Image Guide”) for a more careful explanation of the ramifications of this fact.

If the *mode* argument is 'outline or "outline", then the last argument can be a `pen` struct or an `image-color?`, but if the *mode* is 'solid or "solid", then the last argument must be an `image-color?`.

Example:

```
> (star 40 "solid" "gray")
```



```
(star-polygon side-length
              side-count
              step-count
              mode
              color) → image?
side-length : (and/c real? (not/c negative?))
side-count : side-count?
step-count : step-count?
mode : mode?
color : image-color?
(star-polygon side-length
              side-count
              step-count
              outline-mode
              pen-or-color) → image?
side-length : (and/c real? (not/c negative?))
side-count : side-count?
step-count : step-count?
outline-mode : (or/c 'outline "outline")
pen-or-color : (or/c pen? image-color?)
```

Constructs an arbitrary regular star polygon (a generalization of the regular polygons). The polygon is enclosed by a regular polygon with *side-count* sides each *side-length* long. The polygon is actually constructed by going from vertex to vertex around the regular polygon, but connecting every *step-count*-th vertex (i.e., skipping every `(- step-count 1)` vertices).

For example, if *side-count* is 5 and *step-count* is 2, then this function produces a shape just like `star`.

Note that when the *mode* is `'outline` or `"outline"`, the shape may draw outside of its bounding box and thus parts of the image may disappear when it is cropped. See §2.2.7 “The Nitty Gritty of Pixels, Pens, and Lines” (in the §2.2 “Image Guide”) for a more careful explanation of the ramifications of this fact.

If the *mode* argument is `'outline` or `"outline"`, then the last argument can be a `pen` struct or an `image-color?`, but if the *mode* is `'solid` or `"solid"`, then the last argument must be an `image-color?`.

Examples:

```
> (star-polygon 40 5 2 "solid" "seagreen")
```



```
> (star-polygon 40 7 3 "outline" "darkred")
```



```
> (star-polygon 20 10 3 "solid" "cornflowerblue")
```



```
(radial-star point-count
             inner-radius
             outer-radius
             mode
             color) → image?
point-count : (and/c integer? (>= /c 2))
inner-radius : (and/c real? (not/c negative?))
outer-radius : (and/c real? (not/c negative?))
mode : mode?
color : image-color?
(radial-star point-count
             inner-radius
             outer-radius
             outline-mode
             pen-or-color) → image?
point-count : (and/c integer? (>= /c 2))
inner-radius : (and/c real? (not/c negative?))
outer-radius : (and/c real? (not/c negative?))
outline-mode : (or/c 'outline "outline")
pen-or-color : (or/c pen? image-color?)
```

Constructs a star-like polygon where the star is specified by two radii and a number of points. The first radius determines where the points begin, the second determines where they end, and the *point-count* argument determines how many points the star has.

Examples:

```
> (radial-star 8 8 64 "solid" "darkslategray")
```



```
> (radial-star 32 30 40 "outline" "black")
```

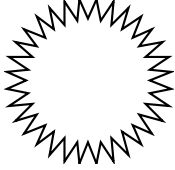

```
(regular-polygon side-length
                 side-count
                 mode
                 color) → image?
side-length : (and/c real? (not/c negative?))
side-count : side-count?
mode : mode?
color : image-color?
(regular-polygon side-length
                 side-count
                 outline-mode
                 pen-or-color) → image?
side-length : (and/c real? (not/c negative?))
side-count : side-count?
outline-mode : (or/c 'outline "outline")
pen-or-color : (or/c pen? image-color?)
```

Constructs a regular polygon with *side-count* sides.

Note that when the *mode* is 'outline or "outline", the shape may draw outside of its bounding box and thus parts of the image may disappear when it is cropped. See §2.2.7 “The Nitty Gritty of Pixels, Pens, and Lines” (in the §2.2 “Image Guide”) for a more careful explanation of the ramifications of this fact.

If the *mode* argument is 'outline or "outline", then the last argument can be a `pen` struct or an `image-color?`, but if the *mode* is 'solid or "solid", then the last argument must be an `image-color?`.

Examples:

```
> (regular-polygon 50 3 "outline" "red")
```

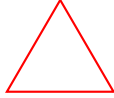

```
> (regular-polygon 40 4 "outline" "blue")
```



```
> (regular-polygon 20 8 "solid" "red")
```

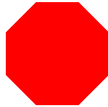

```
(pulled-regular-polygon side-length
                        side-count
                        pull
                        angle
                        mode
                        color) → image?
side-length : (and/c real? (not/c negative?))
side-count : side-count?
pull : (and/c real? (not/c negative?))
angle : angle?
mode : mode?
color : image-color?
(pulled-regular-polygon side-length
                        side-count
                        pull
                        angle
                        outline-mode
                        pen-or-color) → image?
side-length : (and/c real? (not/c negative?))
side-count : side-count?
pull : (and/c real? (not/c negative?))
angle : angle?
outline-mode : (or/c 'outline "outline")
pen-or-color : (or/c pen? image-color?)
```

Constructs a regular polygon with *side-count* sides where each side is curved according to the *pull* and *angle* arguments. The *angle* argument controls the angle at which the curved version of polygon edge makes with the original edge of the polygon. Larger the *pull* arguments mean that the angle is preserved more at each vertex.

Note that when the *mode* is 'outline or "outline", the shape may draw outside of its bounding box and thus parts of the image may disappear when it is cropped. See §2.2.7

“The Nitty Gritty of Pixels, Pens, and Lines” (in the §2.2 “Image Guide”) for a more careful explanation of the ramifications of this fact.

If the *mode* argument is 'outline or "outline", then the last argument can be a *pen* struct or an *image-color?*, but if the *mode* is 'solid or "solid", then the last argument must be an *image-color?*.

Examples:

```
> (pulled-regular-polygon 60 4 1/3 30 "solid" "blue")
```

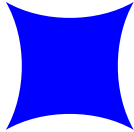

```
> (pulled-regular-polygon 50 5 1/2 -10 "solid" "red")
```

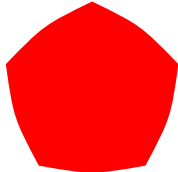

```
> (pulled-regular-polygon 50 5 1 140 "solid" "purple")
```



```
> (pulled-regular-polygon 50 5 1.1 140 "solid" "purple")
```



```
> (pulled-regular-polygon 100 3 1.8 30 "solid" "blue")
```

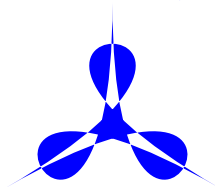

Added in version 1.3 of package `htdp-lib`.

```
(polygon vertices mode color) → image?  
vertices : (listof (or/c real-valued-posn? pulled-point?))
```

```

mode : mode?
color : image-color?
(polygon vertices outline-mode pen-or-color) → image?
vertices : (listof (or/c real-valued-posn? pulled-point?))
outline-mode : (or/c 'outline "outline")
pen-or-color : (or/c pen? image-color?)

```

Constructs a polygon connecting the given vertices.

Note that when the `mode` is `'outline` or `"outline"`, the shape may draw outside of its bounding box and thus parts of the image may disappear when it is cropped. See §2.2.7 “The Nitty Gritty of Pixels, Pens, and Lines” (in the §2.2 “Image Guide”) for a more careful explanation of the ramifications of this fact.

If the `mode` argument is `'outline` or `"outline"`, then the last argument can be a `pen` struct or an `image-color?`, but if the `mode` is `'solid` or `"solid"`, then the last argument must be an `image-color?`.

Examples:

```

> (polygon (list (make-posn 0 0)
                 (make-posn -10 20)
                 (make-posn 60 0)
                 (make-posn -10 -20))
        "solid"
        "burlywood")

```



```

> (polygon (list (make-pulled-point 1/2 20 0 0 1/2 -20)
                 (make-posn -10 20)
                 (make-pulled-point 1/2 -20 60 0 1/2 20)
                 (make-posn -10 -20))
        "solid"
        "burlywood")

```



```

> (polygon (list (make-posn 0 0)
                 (make-posn 0 40)
                 (make-posn 20 40)
                 (make-posn 20 60)
                 (make-posn 40 60)
                 (make-posn 40 20)
                 (make-posn 20 20)
                 (make-posn 20 0))

```

```

      "solid"
      "plum")

```



```

> (underlay
  (rectangle 80 80 "solid" "mediumseagreen")
  (polygon
   (list (make-posn 0 0)
         (make-posn 50 0)
         (make-posn 0 50)
         (make-posn 50 50))
   "outline"
   (make-pen "darkslategray" 10 "solid" "round" "round")))

```



```

> (underlay
  (rectangle 90 80 "solid" "mediumseagreen")
  (polygon
   (list (make-posn 0 0)
         (make-posn 50 0)
         (make-posn 0 50)
         (make-posn 50 50))
   "outline"
   (make-pen "darkslategray" 10 "solid" "projecting" "miter")))

```



Changed in version 1.3 of package `htdp-lib`: Accepts `pulled-points`.

```

(add-polygon image posns mode color) → image?
  image : image?
  posns : (listof posn?)
  mode  : mode?
  color : image-color?

```

Adds a closed polygon to the image *image*, with vertices as specified in *posns* (relative

to the top-left corner of *image*). Unlike `scene+polygon`, if the polygon goes outside the bounds of *image*, the result is enlarged to accommodate both.

Note that when the *mode* is 'outline' or "outline", the shape may draw outside of its bounding box and thus parts of the image may disappear when it is cropped. See §2.2.7 “The Nitty Gritty of Pixels, Pens, and Lines” (in the §2.2 “Image Guide”) for a more careful explanation of the ramifications of this fact.

If the *mode* argument is 'outline' or "outline", then the last argument can be a `pen` struct or an `image-color?`, but if the *mode* is 'solid' or "solid", then the last argument must be an `image-color?`.

Examples:

```
> (add-polygon (square 65 "solid" "light blue")
  (list (make-posn 30 -20)
        (make-posn 50 50)
        (make-posn -20 30))
  "solid" "forest green")
```

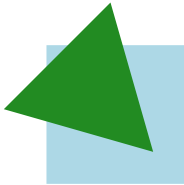

```
> (add-polygon (square 65 "solid" "light blue")
  (list (make-posn 30 -20)
        (make-pulled-point 1/2 30 50 50 1/2 -30)
        (make-posn -20 30))
  "solid" "forest green")
```



```
> (add-polygon (square 180 "solid" "yellow")
  (list (make-posn 109 160)
        (make-posn 26 148)
        (make-posn 46 36)
        (make-posn 93 44)
        (make-posn 89 68)
        (make-posn 122 72))
  "outline" "dark blue")
```

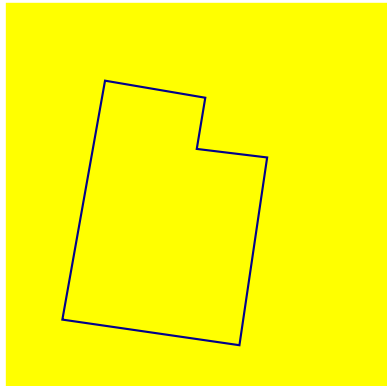

```
> (add-polygon (square 50 "solid" "light blue")
              (list (make-posn 25 -10)
                    (make-posn 60 25)
                    (make-posn 25 60)
                    (make-posn -10 25))
              "solid" "pink")
```

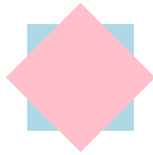

Changed in version 1.3 of package `htdp-lib`: Accepts [pulled-points](#).

```
(scene+polygon image posns mode color) → image?
  image : image?
  posns : (listof posn?)
  mode  : mode?
  color : image-color?
```

Adds a closed polygon to the image *image*, with vertices as specified in *posns* (relative to the top-left corner of *image*). Unlike `add-polygon`, if the polygon goes outside the bounds of *image*, the result is clipped to *image*.

Some shapes (notably those with `'outline` or `"outline"` as the *mode* argument) draw outside of their bounding boxes and thus cropping them may remove part of them (often the lower-left and lower-right edges). See §2.2.7 “The Nitty Gritty of Pixels, Pens, and Lines” (in the §2.2 “Image Guide”) for a more careful discussion of this issue.

Examples:

```
> (scene+polygon (square 65 "solid" "light blue")
                 (list (make-posn 30 -20)
```

```

(make-posn 50 50)
(make-posn -20 30))
"solid" "forest green")

```



```

> (scene+polygon (square 65 "solid" "light blue")
  (list (make-posn 30 -20)
        (make-pulled-point 1/2 -30 50 50 1/2 30)
        (make-posn -20 30))
  "solid" "forest green")

```



```

> (scene+polygon (square 180 "solid" "yellow")
  (list (make-posn 109 160)
        (make-posn 26 148)
        (make-posn 46 36)
        (make-posn 93 44)
        (make-posn 89 68)
        (make-posn 122 72))
  "outline" "dark blue")

```

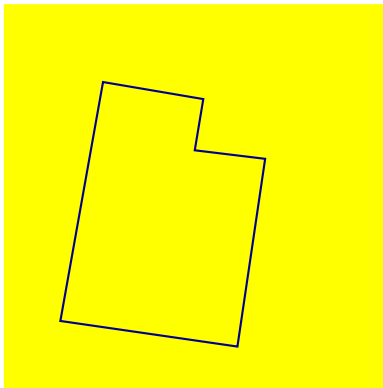

```

> (scene+polygon (square 50 "solid" "light blue")
  (list (make-posn 25 -10)
        (make-posn 60 25)
        (make-posn 25 60)
        (make-posn -10 25))
  "solid" "pink")

```



Changed in version 1.3 of package `htdp-lib`: Accepts [pulled-points](#).

2.3.3 Overlaying Images

```
(overlay i1 i2 is ...) → image?  
  i1 : image?  
  i2 : image?  
  is : image?
```

Overlays all of its arguments building a single image. The first argument goes on top of the second argument, which goes on top of the third argument, etc. The images are all lined up on their centers.

Examples:

```
> (overlay (rectangle 30 60 "solid" "orange")  
          (ellipse 60 30 "solid" "purple"))
```



```
> (overlay (ellipse 10 10 "solid" "red")  
          (ellipse 20 20 "solid" "black")  
          (ellipse 30 30 "solid" "red")  
          (ellipse 40 40 "solid" "black")  
          (ellipse 50 50 "solid" "red")  
          (ellipse 60 60 "solid" "black"))
```



```
> (overlay (regular-polygon 20 5 "solid" (make-color 50 50 255))  
          (regular-polygon 26 5 "solid" (make-color 100 100 255))  
          (regular-polygon 32 5 "solid" (make-color 150 150 255))  
          (regular-polygon 38 5 "solid" (make-color 200 200 255))  
          (regular-polygon 44 5 "solid" (make-  
color 250 250 255)))
```



```
(overlay/align x-place y-place i1 i2 is ...) → image?  
x-place : x-place?  
y-place : y-place?  
i1 : image?  
i2 : image?  
is : image?
```

Overlays all of its image arguments, much like the `overlay` function, but using `x-place` and `y-place` to determine where the images are lined up. For example, if `x-place` and `y-place` are both `"middle"`, then the images are lined up on their centers.

Examples:

```
> (overlay/align "left" "middle"  
  (rectangle 30 60 "solid" "orange")  
  (ellipse 60 30 "solid" "purple"))
```



```
> (overlay/align "right" "bottom"  
  (rectangle 20 20 "solid" "silver")  
  (rectangle 30 30 "solid" "seagreen")  
  (rectangle 40 40 "solid" "silver")  
  (rectangle 50 50 "solid" "seagreen"))
```



```
(overlay/offset i1 x y i2) → image?  
i1 : image?  
x : real?  
y : real?  
i2 : image?
```

Just like `overlay`, this function lines up its image arguments on top of each other. Unlike `overlay`, it moves `i2` by `x` pixels to the right and `y` down before overlaying them.

Examples:

```
> (overlay/offset (circle 40 "solid" "red")
  10 10
  (circle 40 "solid" "blue"))
```

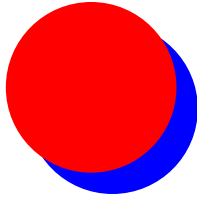

```
> (overlay/offset (overlay/offset (rectangle 60 20 "solid" "black")
  -50 0
  (circle 20 "solid" "darkorange"))
  70 0
  (circle 20 "solid" "darkorange"))
```



```
> (overlay/offset
  (overlay/offset (circle 30 'solid (color 0 150 0 127))
    26 0
    (circle 30 'solid (color 0 0 255 127)))
  0 26
  (circle 30 'solid (color 200 0 0 127)))
```



```
(overlay/align/offset x-place
  y-place
  i1
  x
  y
  i2) → image?

x-place : x-place?
y-place : y-place?
i1 : image?
x : real?
y : real?
i2 : image?
```

Overlays image *i1* on top of *i2*, using *x-place* and *y-place* as the starting points for the overlaying, and then adjusts *i2* by *x* to the right and *y* pixels down.

This function combines the capabilities of [overlay/align](#) and [overlay/offset](#).

Examples:

```
> (overlay/align/offset
  "right" "bottom"
  (star-polygon 20 20 3 "solid" "navy")
  10 10
  (circle 30 "solid" "cornflowerblue"))
```



```
> (overlay/align/offset
  "left" "bottom"
  (star-polygon 20 20 3 "solid" "navy")
  -10 10
  (circle 30 "solid" "cornflowerblue"))
```

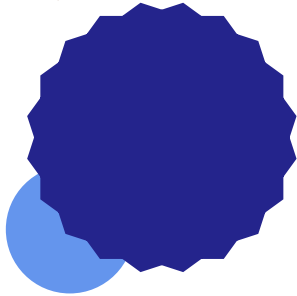

```
(overlay/xy i1 x y i2) → image?
  i1 : image?
  x  : real?
  y  : real?
  i2 : image?
```

Constructs an image by overlaying *i1* on top of *i2*. The images are initially lined up on their upper-left corners and then *i2* is shifted to the right by *x* pixels and down by *y* pixels.

This is the same as `(underlay/xy i2 (- x) (- y) i1)`.

See also [overlay/offset](#) and [underlay/offset](#).

Examples:

```
> (overlay/xy (rectangle 20 20 "outline" "black")
              20 0
              (rectangle 20 20 "outline" "black"))
```



```
> (overlay/xy (rectangle 20 20 "solid" "red")
              10 10
              (rectangle 20 20 "solid" "black"))
```



```
> (overlay/xy (rectangle 20 20 "solid" "red")
              -10 -10
              (rectangle 20 20 "solid" "black"))
```



```
> (overlay/xy
  (overlay/xy (ellipse 40 40 "outline" "black")
              10
              15
              (ellipse 10 10 "solid" "forestgreen"))
  20
  15
  (ellipse 10 10 "solid" "forestgreen"))
```



```
(underlay i1 i2 is ...) → image?
  i1 : image?
  i2 : image?
  is : image?
```

Underlays all of its arguments building a single image.

It behaves like `overlay`, but with the arguments in the reverse order. That is, the first argument goes underneath of the second argument, which goes underneath the third argument, etc. The images are all lined up on their centers.

Examples:

```
> (underlay (rectangle 30 60 "solid" "orange")
            (ellipse 60 30 "solid" "purple"))
```

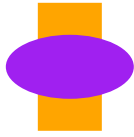

```
> (underlay (ellipse 10 60 "solid" "red")
           (ellipse 20 50 "solid" "black")
           (ellipse 30 40 "solid" "red")
           (ellipse 40 30 "solid" "black")
           (ellipse 50 20 "solid" "red")
           (ellipse 60 10 "solid" "black"))
```



```
> (underlay (ellipse 10 60 40 "red")
           (ellipse 20 50 40 "red")
           (ellipse 30 40 40 "red")
           (ellipse 40 30 40 "red")
           (ellipse 50 20 40 "red")
           (ellipse 60 10 40 "red"))
```

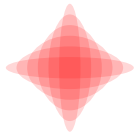

```
(underlay/align x-place y-place i1 i2 is ...) → image?
x-place : x-place?
y-place : y-place?
i1      : image?
i2      : image?
is      : image?
```

Underlays all of its image arguments, much like the `underlay` function, but using `x-place` and `y-place` to determine where the images are lined up. For example, if `x-place` and `y-place` are both `"middle"`, then the images are lined up on their centers.

Examples:

```
> (underlay/align "left" "middle"
   (rectangle 30 60 "solid" "orange")
   (ellipse 60 30 "solid" "purple"))
```

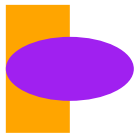

```
> (underlay/align "right" "top"
    (rectangle 50 50 "solid" "seagreen")
    (rectangle 40 40 "solid" "silver")
    (rectangle 30 30 "solid" "seagreen")
    (rectangle 20 20 "solid" "silver"))
```



```
> (underlay/align "left" "middle"
    (rectangle 50 50 50 "seagreen")
    (rectangle 40 40 50 "seagreen")
    (rectangle 30 30 50 "seagreen")
    (rectangle 20 20 50 "seagreen"))
```



```
(underlay/offset i1 x y i2) → image?
  i1 : image?
  x  : real?
  y  : real?
  i2 : image?
```

Just like `underlay`, this function lines up its first image argument underneath the second. Unlike `underlay`, it moves `i2` by `x` pixels to the right and `y` down before underlaying them.

Examples:

```
> (underlay/offset (circle 40 "solid" "red")
    10 10
    (circle 40 "solid" "blue"))
```

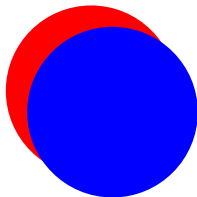

```
> (underlay/offset (circle 40 "solid" "gray")
    0 -10
    (underlay/offset (circle 10 "solid" "navy")
        -30 0
        (circle 10 "solid" "navy")))
```

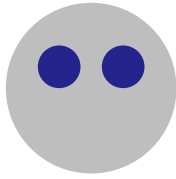

```
(underlay/align/offset x-place
                       y-place
                       i1
                       x
                       y
                       i2) → image?
x-place : x-place?
y-place : y-place?
i1 : image?
x : real?
y : real?
i2 : image?
```

Underlays image *i1* underneath *i2*, using *x-place* and *y-place* as the starting points for the combination, and then adjusts *i2* by *x* to the right and *y* pixels down.

This function combines the capabilities of `underlay/align` and `underlay/offset`.

Examples:

```
> (underlay/align/offset
   "right" "bottom"
   (star-polygon 20 20 3 "solid" "navy")
   10 10
   (circle 30 "solid" "cornflowerblue"))
```

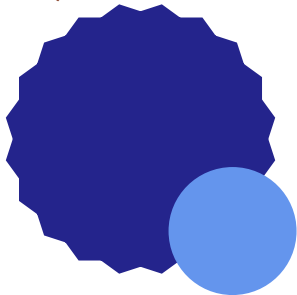

```
> (underlay/align/offset
   "right" "bottom"
   (underlay/align/offset
    "left" "bottom"
    (underlay/align/offset
```

```

"right" "top"
(underlay/align/offset
 "left" "top"
 (rhombus 120 90 "solid" "navy")
 16 16
 (star-polygon 20 11 3 "solid" "cornflowerblue"))
-16 16
(star-polygon 20 11 3 "solid" "cornflowerblue"))
16 -16
(star-polygon 20 11 3 "solid" "cornflowerblue"))
-16 -16
(star-polygon 20 11 3 "solid" "cornflowerblue"))

```

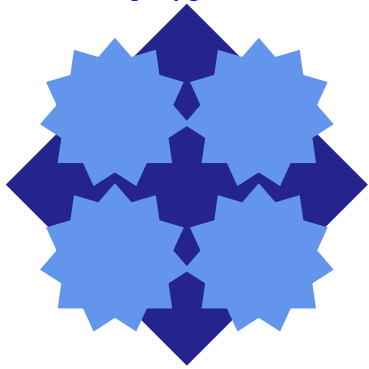

```

(underlay/xy i1 x y i2) → image?
  i1 : image?
   x : real?
   y : real?
  i2 : image?

```

Constructs an image by underlaying *i1* underneath *i2*. The images are initially lined up on their upper-left corners and then *i2* is shifted to the right by *x* pixels to and down by *y* pixels.

This is the same as `(overlay/xy i2 (- x) (- y) i1)`.

See also `underlay/offset` and `overlay/offset`.

Examples:

```

> (underlay/xy (rectangle 20 20 "outline" "black")
 20 0
 (rectangle 20 20 "outline" "black"))

```



```

> (underlay/xy (rectangle 20 20 "solid" "red")
              10 10
              (rectangle 20 20 "solid" "black"))

```



```

> (underlay/xy (rectangle 20 20 "solid" "red")
              -10 -10
              (rectangle 20 20 "solid" "black"))

```



```

> (underlay/xy
  (underlay/xy (ellipse 40 40 "solid" "gray")
              10
              15
              (ellipse 10 10 "solid" "forestgreen"))
  20
  15
  (ellipse 10 10 "solid" "forestgreen"))

```



```

(beside i1 i2 is ...) → image?
i1 : image?
i2 : image?
is : image?

```

Constructs an image by placing all of the argument images in a horizontal row, aligned along their centers.

Example:

```

> (beside (ellipse 20 70 "solid" "gray")
          (ellipse 20 50 "solid" "darkgray")
          (ellipse 20 30 "solid" "dimgray")
          (ellipse 20 10 "solid" "black"))

```

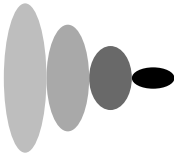

```

(beside/align y-place i1 i2 is ...) → image?
y-place : y-place?

```

```
i1 : image?  
i2 : image?  
is : image?
```

Constructs an image by placing all of the argument images in a horizontal row, lined up as indicated by the *y-place* argument. For example, if *y-place* is "middle", then the images are placed side by side with their centers lined up with each other.

Examples:

```
> (beside/align "bottom"  
   (ellipse 20 70 "solid" "lightsteelblue")  
   (ellipse 20 50 "solid" "mediumslateblue")  
   (ellipse 20 30 "solid" "slateblue")  
   (ellipse 20 10 "solid" "navy"))
```

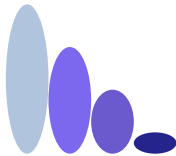

```
> (beside/align "top"  
   (ellipse 20 70 "solid" "mediumorchid")  
   (ellipse 20 50 "solid" "darkorchid")  
   (ellipse 20 30 "solid" "purple")  
   (ellipse 20 10 "solid" "indigo"))
```

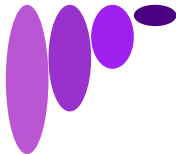

```
> (beside/align "baseline"  
   (text "ijy" 18 "black")  
   (text "ijy" 24 "black"))
```

ijyijy

```
(above i1 i2 is ...) → image?  
i1 : image?  
i2 : image?  
is : image?
```

Constructs an image by placing all of the argument images in a vertical row, aligned along their centers.

Example:

```
> (above (ellipse 70 20 "solid" "gray")
         (ellipse 50 20 "solid" "darkgray")
         (ellipse 30 20 "solid" "dimgray")
         (ellipse 10 20 "solid" "black"))
```

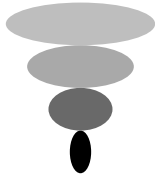

```
(above/align x-place i1 i2 is ...) → image?
  x-place : x-place?
  i1 : image?
  i2 : image?
  is : image?
```

Constructs an image by placing all of the argument images in a vertical row, lined up as indicated by the *x-place* argument. For example, if *x-place* is "middle", then the images are placed above each other with their centers lined up.

Examples:

```
> (above/align "right"
         (ellipse 70 20 "solid" "gold")
         (ellipse 50 20 "solid" "goldenrod")
         (ellipse 30 20 "solid" "darkgoldenrod")
         (ellipse 10 20 "solid" "sienna"))
```



```
> (above/align "left"
         (ellipse 70 20 "solid" "yellowgreen")
         (ellipse 50 20 "solid" "olivedrab")
         (ellipse 30 20 "solid" "darkolivegreen")
         (ellipse 10 20 "solid" "darkgreen"))
```



2.3.4 Placing Images & Scenes

Placing images into scenes is particularly useful when building worlds and universes using `2htdp/universe`.

```
(empty-scene width height) → image?  
  width : (and/c real? (not/c negative?))  
  height : (and/c real? (not/c negative?))  
(empty-scene width height color) → image?  
  width : (and/c real? (not/c negative?))  
  height : (and/c real? (not/c negative?))  
  color : image-color?
```

Creates an empty scene, i.e., a white rectangle with a black outline.

Example:

```
> (empty-scene 160 90)
```



The three-argument version creates a rectangle of the specified color with a black outline.

```
(place-image image x y scene) → image?  
  image : image?  
  x : real?  
  y : real?  
  scene : image?
```

Places *image* onto *scene* with its center at the coordinates (*x*,*y*) and crops the resulting image so that it has the same size as *scene*. The coordinates are relative to the top-left of *scene*.

Some shapes (notably those with `'outline` or `"outline"` as the *mode* argument) draw outside of their bounding boxes and thus cropping them may remove part of them (often the lower-left and lower-right edges). See §2.2.7 “The Nitty Gritty of Pixels, Pens, and Lines” (in the §2.2 “Image Guide”) for a more careful discussion of this issue.

Examples:

```
> (place-image
```

```
(triangle 32 "solid" "red")
24 24
(rectangle 48 48 "solid" "gray"))
```



```
> (place-image
  (triangle 64 "solid" "red")
  24 24
  (rectangle 48 48 "solid" "gray"))
```



```
> (place-image
  (circle 4 "solid" "white")
  18 20
  (place-image
    (circle 4 "solid" "white")
    0 6
    (place-image
      (circle 4 "solid" "white")
      14 2
      (place-image
        (circle 4 "solid" "white")
        8 14
        (rectangle 24 24 "solid" "goldenrod"))))))
```



```
(place-image/align image
  x
  y
  x-place
  y-place
  scene) → image?

image : image?
x : real?
y : real?
x-place : x-place?
y-place : y-place?
scene : image?
```

Like `place-image`, but uses `image`'s `x-place` and `y-place` to anchor the image. Also,

like `place-image`, `place-image/align` crops the resulting image so that it has the same size as `scene`.

Some shapes (notably those with `'outline` or `"outline"` as the `mode` argument) draw outside of their bounding boxes and thus cropping them may remove part of them (often the lower-left and lower-right edges). See §2.2.7 “The Nitty Gritty of Pixels, Pens, and Lines” (in the §2.2 “Image Guide”) for a more careful discussion of this issue.

Examples:

```
> (place-image/align (triangle 48 "solid" "yellowgreen")
  64 64 "right" "bottom"
  (rectangle 64 64 "solid" "mediumgoldenrod"))
```



```
> (beside
  (place-image/align (circle 8 "solid" "tomato")
    0 0 "center" "center"
    (rectangle 32 32 "outline" "black"))
  (place-image/align (circle 8 "solid" "tomato")
    8 8 "center" "center"
    (rectangle 32 32 "outline" "black"))
  (place-image/align (circle 8 "solid" "tomato")
    16 16 "center" "center"
    (rectangle 32 32 "outline" "black"))
  (place-image/align (circle 8 "solid" "tomato")
    24 24 "center" "center"
    (rectangle 32 32 "outline" "black"))
  (place-image/align (circle 8 "solid" "tomato")
    32 32 "center" "center"
    (rectangle 32 32 "outline" "black")))
```

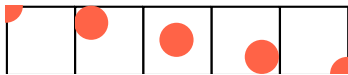

```
(place-images images posns scene) → image?
  images : (listof image?)
  posns  : (listof posn?)
  scene  : image?
```

Places each of `images` into `scene` like `place-image` would, using the coordinates in `posns` as the `x` and `y` arguments to `place-image`.

Some shapes (notably those with `'outline` or `"outline"` as the `mode` argument) draw outside of their bounding boxes and thus cropping them may remove part of them (often the

lower-left and lower-right edges). See §2.2.7 “The Nitty Gritty of Pixels, Pens, and Lines” (in the §2.2 “Image Guide”) for a more careful discussion of this issue.

Example:

```
> (place-images
  (list (circle 4 "solid" "white")
        (circle 4 "solid" "white")
        (circle 4 "solid" "white")
        (circle 4 "solid" "white"))
  (list (make-posn 18 20)
        (make-posn 0 6)
        (make-posn 14 2)
        (make-posn 8 14))
  (rectangle 24 24 "solid" "goldenrod"))
```



```
(place-images/align images
                    posns
                    x-place
                    y-place
                    scene) → image?
images : (listof image?)
posns  : (listof posn?)
x-place : x-place?
y-place : y-place?
scene  : image?
```

Like `place-images`, except that it places the images with respect to `x-place` and `y-place`.

Some shapes (notably those with `'outline` or `"outline"` as the `mode` argument) draw outside of their bounding boxes and thus cropping them may remove part of them (often the lower-left and lower-right edges). See §2.2.7 “The Nitty Gritty of Pixels, Pens, and Lines” (in the §2.2 “Image Guide”) for a more careful discussion of this issue.

Example:

```
> (place-images/align
  (list (triangle 48 "solid" "yellowgreen")
        (triangle 48 "solid" "yellowgreen")
        (triangle 48 "solid" "yellowgreen")
        (triangle 48 "solid" "yellowgreen"))
  (list (make-posn 64 64)
        (make-posn 64 48))
```

```

      (make-posn 64 32)
      (make-posn 64 16))
  "right" "bottom"
  (rectangle 64 64 "solid" "mediumgoldenrod"))

```



```

(put-image image x y scene) → image?
  image : image?
  x : real?
  y : real?
  scene : image?

```

Places *image* onto *scene* with its center at the coordinates (*x*,*y*) and crops the resulting image so that it has the same size as *scene*. The coordinates are relative to the bottom-left of *scene* and *y* increasing goes upwards, not downwards.

Some shapes (notably those with 'outline or "outline" as the *mode* argument) draw outside of their bounding boxes and thus cropping them may remove part of them (often the lower-left and lower-right edges). See §2.2.7 “The Nitty Gritty of Pixels, Pens, and Lines” (in the §2.2 “Image Guide”) for a more careful discussion of this issue.

Examples:

```

> (put-image
  (ellipse 20 30 "solid" "red")
  40 15
  (rectangle 50 50 "solid" "gray"))

```



```

> (place-image
  (ellipse 20 30 "solid" "red")
  40 15
  (rectangle 50 50 "solid" "gray"))

```



```

(scene+line scene x1 y1 x2 y2 pen-or-color) → image?
  scene : image?

```

```

x1 : real?
y1 : real?
x2 : real?
y2 : real?
pen-or-color : (or/c pen? image-color?)

```

Adds a line to the image *scene*, starting from the point $(x1,y1)$ and going to the point $(x2,y2)$; unlike `add-line`, this function crops the resulting image to the size of *scene*.

Some shapes (notably those with 'outline' or "outline" as the *mode* argument) draw outside of their bounding boxes and thus cropping them may remove part of them (often the lower-left and lower-right edges). See §2.2.7 “The Nitty Gritty of Pixels, Pens, and Lines” (in the §2.2 “Image Guide”) for a more careful discussion of this issue.

Examples:

```

> (scene+line (ellipse 40 40 "outline" "maroon")
      0 40 40 0 "maroon")

```



```

> (scene+line (rectangle 40 40 "solid" "gray")
      -10 50 50 -10 "maroon")

```



```

> (scene+line
  (rectangle 100 100 "solid" "darkolivegreen")
  25 25 100 100
  (make-pen "goldenrod" 30 "solid" "round" "round"))

```

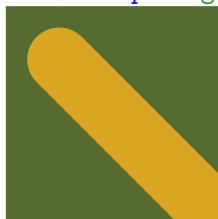

```

(scene+curve scene
  x1
  y1
  angle1
  pull1
  x2
  y2
  angle2
  pull2
  color) → image?
scene : image?
x1 : real?
y1 : real?
angle1 : angle?
pull1 : real?
x2 : real?
y2 : real?
angle2 : angle?
pull2 : real?
color : (or/c pen? image-color?)

```

Adds a curve to *scene*, starting at the point (*x1,y1*), and ending at the point (*x2,y2*).

The *angle1* and *angle2* arguments specify the angle that the curve has as it leaves the initial point and as it reaches the final point, respectively.

The *pull1* and *pull2* arguments control how long the curve tries to stay with that angle. Larger numbers mean that the curve stays with the angle longer.

Unlike `add-curve`, this function crops the curve, only showing the parts that fit onto *scene*.

Some shapes (notably those with 'outline or "outline" as the *mode* argument) draw outside of their bounding boxes and thus cropping them may remove part of them (often the lower-left and lower-right edges). See §2.2.7 “The Nitty Gritty of Pixels, Pens, and Lines” (in the §2.2 “Image Guide”) for a more careful discussion of this issue.

Examples:

```

> (scene+curve (rectangle 100 100 "solid" "black")
  20 20 0 1/3
  80 80 0 1/3
  "white")

```

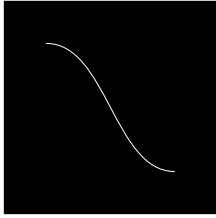

```
> (scene+curve (rectangle 100 100 "solid" "black")
              20 20 0 1
              80 80 0 1
              "white")
```

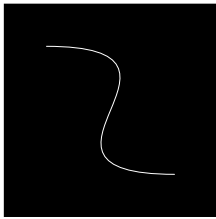

```
> (scene+curve
  (add-curve
    (rectangle 40 100 "solid" "black")
    20 10 180 1/2
    20 90 180 1/2
    "white")
  20 10 0 1/2
  20 90 0 1/2
  "white")
```



```
> (scene+curve (rectangle 100 100 "solid" "black")
              -20 -20 0 1
              120 120 0 1
              "red")
```

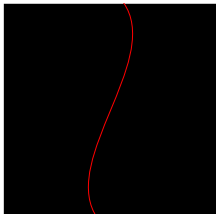

2.3.5 Rotating, Scaling, Flipping, Cropping, and Framing Images

```
(rotate angle image) → image?  
  angle : angle?  
  image : image?
```

Rotates *image* by *angle* degrees in a counter-clockwise direction.

Examples:

```
> (rotate 45 (ellipse 60 20 "solid" "olivedrab"))
```



```
> (rotate 5 (rectangle 50 50 "outline" "black"))
```

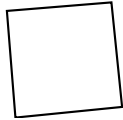

```
> (rotate 45  
  (beside/align  
    "center"  
    (rectangle 40 20 "solid" "darkseagreen")  
    (rectangle 20 100 "solid" "darkseagreen")))
```



See also §2.2.5 “Rotating and Image Centers”.

```
(scale factor image) → image?  
  factor : (and/c real? positive?)  
  image : image?
```

Scales *image* by *factor*.

The pen sizes are also scaled and thus draw thicker (or thinner) lines than the original image, unless the pen was size 0. That pen size is treated specially to mean “the smallest available line” and thus it always draws a one-pixel wide line; this is also the case for 'outline and "outline" shapes that are drawn with an *image-color?* instead of a *pen*.

Examples:

```
> (scale 2 (ellipse 20 30 "solid" "blue"))
```



```
> (ellipse 40 60 "solid" "blue")
```



```
(scale/xy x-factor y-factor image) → image?  
x-factor : (and/c real? positive?)  
y-factor : (and/c real? positive?)  
image : image?
```

Scales *image* by *x-factor* horizontally and by *y-factor* vertically.

Examples:

```
> (scale/xy 3  
          2  
          (ellipse 20 30 "solid" "blue"))
```

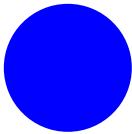

```
> (ellipse 60 60 "solid" "blue")
```

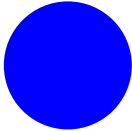

```
(flip-horizontal image) → image?  
image : image?
```

Flips *image* left to right.

Flipping images with text is not supported (so passing `flip-horizontal` an image that contains a `text` or `text/font` image inside somewhere signals an error).

Example:

```
> (beside
```

```
(rotate 30 (square 50 "solid" "red"))
(flip-horizontal
 (rotate 30 (square 50 "solid" "blue"))))
```

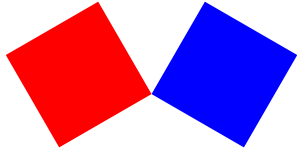

```
(flip-vertical image) → image?
image : image?
```

Flips *image* top to bottom.

Flipping images with text is not supported (so passing `flip-vertical` an image that contains a `text` or `text/font` image inside somewhere signals an error).

Example:

```
> (above
 (star 40 "solid" "firebrick")
 (scale/xy 1 1/2 (flip-vertical (star 40 "solid" "gray"))))
```



```
(crop x y width height image) → image?
x : real?
y : real?
width : (and/c real? (not/c negative?))
height : (and/c real? (not/c negative?))
image : image?
```

Crops *image* to the rectangle with the upper left at the point (x,y) and with *width* and *height*.

Some shapes (notably those with `'outline` or `"outline"` as the *mode* argument) draw outside of their bounding boxes and thus cropping them may remove part of them (often the lower-left and lower-right edges). See §2.2.7 “The Nitty Gritty of Pixels, Pens, and Lines” (in the §2.2 “Image Guide”) for a more careful discussion of this issue.

Examples:

```
> (crop 0 0 40 40 (circle 40 "solid" "chocolate"))
```



```
> (crop 40 60 40 60 (ellipse 80 120 "solid" "dodgerblue"))
```



```
> (above
  (beside (crop 40 40 40 40 (circle 40 "solid" "palevioletred"))
    (crop 0 40 40 40 (circle 40 "solid" "lightcoral")))
  (beside (crop 40 0 40 40 (circle 40 "solid" "lightcoral"))
    (crop 0 0 40 40 (circle 40 "solid" "palevioletred"))))
```

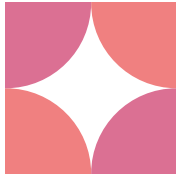

```
(crop/align x-place
            y-place
            width
            height
            image) → image?
x-place : x-place?
y-place : y-place?
width   : (and/c real? (not/c negative?))
height  : (and/c real? (not/c negative?))
image   : image?
```

Crops *image* to a rectangle whose size is *width* and *height* and is positioned based on *x-place* and *y-place*.

Some shapes (notably those with 'outline or "outline" as the *mode* argument) draw outside of their bounding boxes and thus cropping them may remove part of them (often the lower-left and lower-right edges). See §2.2.7 “The Nitty Gritty of Pixels, Pens, and Lines” (in the §2.2 “Image Guide”) for a more careful discussion of this issue.

Examples:

```
> (crop/align "left" "top" 40 40 (circle 40 "solid" "chocolate"))
```



```
> (crop/align "right" "bottom" 40 60 (ellipse 80 120 "solid" "dodgerblue"))
```



```
> (crop/align "center" "center" 50 30 (circle 25 "solid" "mediumslateblue"))
```



```
> (above  
  (beside (crop/align "right" "bottom" 40 40 (circle 40 "solid" "palevioletred"))  
          (crop/align "left" "bottom" 40 40 (circle 40 "solid" "lightcoral")))  
  (beside (crop/align "right" "top" 40 40 (circle 40 "solid" "lightcoral"))  
          (crop/align "left" "top" 40 40 (circle 40 "solid" "palevioletred"))))
```



Added in version 1.1 of package `htdp-lib`.

```
(frame image) → image?  
image : image?
```

Returns an image just like `image`, except with a black, single pixel frame drawn around the bounding box of the image.

Example:

```
> (frame (ellipse 40 40 "solid" "gray"))
```



Generally speaking, this function is useful to debug image constructions, i.e., to see where certain sub-images appear within some larger image.

Example:

```
> (beside  
  (ellipse 20 70 "solid" "lightsteelblue")  
  (frame (ellipse 20 50 "solid" "mediumslateblue"))  
  (ellipse 20 30 "solid" "slateblue")  
  (ellipse 20 10 "solid" "navy"))
```

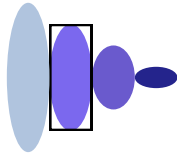

```
(color-frame color image) → image?  
  color : (or/c pen? image-color?)  
  image : image?
```

Like `frame`, except with the given `color`.

Added in version 1.1 of package `htdp-lib`.

2.3.6 Bitmaps

DrRacket's Insert Image ... menu item allows you to insert images into your program text, and those images are treated as images for this library.

Unlike all of the other images in this library, those images (and the other images created by functions in this section of the documentation) are represented as bitmaps, i.e., an array of colors (that can be quite large in some cases). This means that scaling and rotating them loses fidelity in the image and is significantly more expensive than with the other shapes.

See also the `2htdp/planetcute` library.

```
(bitmap bitmap-spec)  
  
bitmap-spec = rel-string  
             | id
```

Loads the bitmap specified by `bitmap-spec`. If `bitmap-spec` is a string, it is treated as a relative path. If it is an identifier, it is treated like a require spec and used to refer to a file in a collection.

Examples:

```
> (bitmap icons/stop-16x16.png)
```



```
> (bitmap icons/b-run.png)
```



```
(bitmap/url url) → image?  
  url : string?
```

Goes out on the web and downloads the image at *url*.

Downloading the image happens each time this function is called, so you may find it simpler to download the image once with a browser and then paste it into your program or download it and use `bitmap`.

```
(bitmap/file ps) → image?  
ps : path-string?
```

Loads the image from *ps*.

If *ps* is a relative path, the file is relative to the current directory. (When running in DrRacket, the current directory is set to the place where the definitions window is saved, but in general this can be an arbitrary directory.)

```
(image->color-list image) → (listof color?)  
image : image?
```

Returns a list of colors that correspond to the colors in the image, reading from left to right, top to bottom.

The list of colors is obtained by drawing the image on a white background and then reading off the colors of the pixels that were drawn.

Examples:

```
> (image->color-list (rectangle 2 2 "solid" "black"))  
(list (color 0 0 0 255) (color 0 0 0 255) (color 0 0 0 255) (color  
0 0 0 255))  
> (image->color-list  
  (above (beside (rectangle 1 1 "solid" (make-color 1 1 1))  
                (rectangle 1 1 "solid" (make-color 2 2 2))))  
  (beside (rectangle 1 1 "solid" (make-color 3 3 3))  
          (rectangle 1 1 "solid" (make-color 4 4 4))))  
(list (color 1 1 1 255) (color 2 2 2 255) (color 3 3 3 255) (color  
4 4 4 255))
```

```
(color-list->bitmap colors width height) → image?  
colors : (listof image-color?)  
width : (and/c real? (not/c negative?))  
height : (and/c real? (not/c negative?))
```

Constructs a bitmap from the given *colors*, with the given *width* and *height*.

Example:

```
> (scale
  40
  (color-list->bitmap
   (list "red" "green" "blue")
   3 1))
```

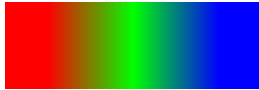

```
(freeze image) → image?
  image : image?
(freeze width height image) → image?
  width : (and/c real? (not/c negative?))
  height : (and/c real? (not/c negative?))
  image : image?
(freeze x y width height image) → image?
  x : real?
  y : real?
  width : (and/c real? (not/c negative?))
  height : (and/c real? (not/c negative?))
  image : image?
```

Freezing an image internally builds a bitmap, crops the image, draws the cropped image into the bitmap and then uses the bitmap to draw that image afterwards. Typically this is used as a performance hint. When an image both contains many sub-images and is going to be drawn many times (but not scaled or rotated), using freeze on the image can substantially improve performance without changing how the image draws (assuming it draws only inside its bounding box; see also §2.2.7 “The Nitty Gritty of Pixels, Pens, and Lines”).

If `freeze` is passed only the image argument, then it crops the image to its bounding box. If it is given three arguments, the two numbers are used as the width and height and the five argument version fully specifies where to crop the image.

2.3.7 Image Properties

```
(image-width i) → (and/c integer? (not/c negative?) exact?)
  i : image?
```

Returns the width of *i*.

Examples:

```
> (image-width (ellipse 30 40 "solid" "orange"))
30
```

```

> (image-width (circle 30 "solid" "orange"))
60
> (image-width (beside (circle 20 "solid" "orange")
                       (circle 20 "solid" "purple")))
80
> (image-width (rectangle 0 10 "solid" "purple"))
0

```

```

(image-height i) → (and/c integer? (not/c negative?) exact?)
i : image?

```

Returns the height of *i*.

Examples:

```

> (image-height (ellipse 30 40 "solid" "orange"))
40
> (image-height (circle 30 "solid" "orange"))
60
> (image-height (overlay (circle 20 "solid" "orange")
                        (circle 30 "solid" "purple")))
60
> (image-height (rectangle 10 0 "solid" "purple"))
0

```

```

(image-baseline i) → (and/c integer? (not/c negative?) exact?)
i : image?

```

Returns the distance from the top of the image to its baseline. The baseline of an image is the place where the bottoms any letters line up, but without counting the descenders, e.g. the tail on “y” or “g” or “j”.

Unless the image was constructed with `text`, `text/font` or, in some cases, `crop`, this will be the same as its height.

Examples:

```

> (image-baseline (text "Hello" 24 "black"))
18
> (image-height (text "Hello" 24 "black"))
24
> (image-baseline (rectangle 100 100 "solid" "black"))
100
> (image-height (rectangle 100 100 "solid" "black"))
100

```

A [cropped](#) image's baseline is the same as the image's baseline, if the cropping stays within the original image's bounding box. But if the cropping actually enlarges the image, then the baseline can end up being smaller.

Examples:

```
> (image-height (rectangle 20 20 "solid" "black"))
20
> (image-baseline (rectangle 20 20 "solid" "black"))
20
> (image-height (crop 10 10 5 5 (rectangle 20 20 "solid" "black")))
5
> (image-baseline (crop 10 10 5 5 (rectangle 20 20 "solid" "black")))
5
> (image-height (crop 10 10 30 30 (rectangle 20 20 "solid" "black")))
30
> (image-baseline (crop 10 10 30 30 (rectangle 20 20 "solid" "black")))
20
```

2.3.8 Image Predicates

This section lists predicates for the basic structures provided by the image library.

```
(image? x) → boolean?
x : any/c
```

Determines if *x* is an image. Images are returned by functions like [ellipse](#) and [rectangle](#) and accepted by functions like [overlay](#) and [beside](#).

Additionally, images inserted into a DrRacket window are treated as bitmap images, as are instances of [image-snip%](#) and [bitmap%](#).

```
(mode? x) → boolean?
x : any/c
```

Determines if *x* is a mode suitable for constructing images.

It can be one of `'solid`, `"solid"`, `'outline`, or `"outline"`, indicating if the shape is filled in or not.

It can also be an integer between 0 and 255 (inclusive) indicating the transparency of the image. The integer 255 is fully opaque, and is the same as `"solid"` (or `'solid`). The integer 0 means fully transparent.

```
(image-color? x) → boolean?
x : any/c
```

Determines if `x` represents a color. Strings, symbols, and `color` structs are allowed as colors.

For example, `"magenta"`, `"black"`, `'orange`, and `'purple` are allowed. Colors are not case-sensitive, so `"Magenta"`, `"Black"`, `'Orange`, and `'Purple` are also allowed, and are the same colors as in the previous sentence. Additionally, spaces are not considered, so `"light orange"` is the same color as `"lightorange"`.

The complete list of colors is the same as the colors allowed in `color-database< %>`, plus the color `"transparent"`, a transparent color, as well as the following variants of the colors: Brown, Cyan, Goldenrod, Gray, Green, Orange, Pink, Purple, Red, Turquoise, and Yellow.

	Light Brown
	Medium Brown
	Dark Brown
	Medium Cyan
	Light Goldenrod
	Medium Gray
	Medium Green
	Light Orange
	Medium Orange
	Medium Pink
	Dark Pink
	Light Purple
	Dark Purple
	Light Red
	Medium Red
	Light Turquoise
	Medium Yellow



Dark Yellow

```
(struct color (red green blue alpha)
  #:extra-constructor-name make-color)
red : (integer-in 0 255)
green : (integer-in 0 255)
blue : (integer-in 0 255)
alpha : (integer-in 0 255)
```

The `color` struct defines a color with `red`, `green`, `blue`, and `alpha` components that range from 0 to 255.

The `red`, `green`, and `blue` fields combine to make a color, with the higher values meaning more of the given color. For example, `(make-color 255 0 0)` makes a bright red color and `(make-color 255 0 255)` makes a bright purple.

The `alpha` field controls the transparency of the color. A value of 255 means that the color is opaque and 0 means the color is fully transparent.

The constructor, `make-color`, also accepts only three arguments, in which case the three arguments are used for the `red`, `green`, and `blue` fields, and the `alpha` field defaults to 255.

```
(struct pulled-point (lpull langle x y rpull rangle)
  #:extra-constructor-name make-pulled-point)
lpull : real?
langle : angle?
x : real?
y : real?
rpull : real?
rangle : angle?
```

The `pulled-point` struct defines a point with `x` and `y` coordinates, but also with two angles (`langle` and `rangle`) and two pulls (`lpull` and `rpull`).

These points are used with the `polygon` function and control how the edges can be curved.

The first two pull and angle arguments indicate how an edge coming into this point should be curved. The angle argument indicates the angle as the edge reaches `(x,y)` and a larger pull argument means that the edge should hold the angle longer. The last two are the same, except they apply to the edge leaving the point.

Added in version 1.3 of package `htdp-lib`.

```
(y-place? x) → boolean?
x : any/c
```

Determines if `x` is a placement option for the vertical direction. It can be one of `"top"`, `'top`, `"bottom"`, `'bottom`, `"middle"`, `'middle`, `"center"`, `'center`, `"baseline"`, `'baseline`, `"pinhole"`, or `'pinhole`.

Using `"pinhole"` or `'pinhole` is only allowed when all of the image arguments have pinholes.

See also `image-baseline` for more discussion of baselines.

```
(x-place? x) → boolean?  
x : any/c
```

Determines if `x` is a placement option for the horizontal direction. It can be one of `"left"`, `'left`, `"right"`, `'right`, `"middle"`, `'middle`, `"center"`, `'center`, `"pinhole"`, or `'pinhole`.

Using `"pinhole"` or `'pinhole` is only allowed when all of the image arguments have pinholes.

```
(angle? x) → boolean?  
x : any/c
```

Determines if `x` is an angle, namely a real number (except not `+inf.0`, `-inf.0` or `+nan.0`).

Angles are in degrees, so 0 is the same as 360, 90 means rotating one quarter of the way around a circle, and 180 is halfway around a circle.

```
(side-count? x) → boolean?  
x : any/c
```

Determines if `x` is an integer greater than or equal to 3.

```
(step-count? x) → boolean?  
x : any/c
```

Determines if `x` is an integer greater than or equal to 1.

```
(real-valued-posn? x) → boolean?  
x : any/c
```

Determines if `x` is a `posn` whose `x` and `y` fields are both `real?` numbers.

```
(struct pen (color width style cap join)  
 #:extra-constructor-name make-pen)  
 color : image-color?
```

```
width : (and/c real? (<=/c 0 255))
style : pen-style?
cap : pen-cap?
join : pen-join?
```

The `pen` struct specifies how the drawing library draws lines.

A good default for `style` is `"solid"`, and good default values for the `cap` and `join` fields are `"round"`.

Using `0` as a width is special; it means to always draw the smallest possible, but visible, pen. This means that the pen will always be one pixel in size, no matter how the image is scaled.

The `cap` determines how the ends of a curve is drawn.

The `join` determines how two lines are joined.

Examples:

```
> (line 400 100 (pen "red" 10 "long-dash" "round" "bevel"))
```

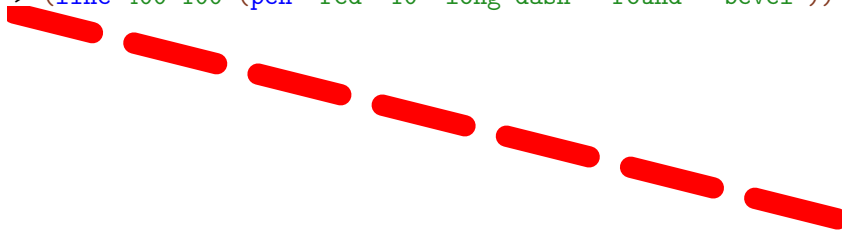

```
> (line 400 100 (pen "red" 10 "short-dash" "round" "bevel"))
```

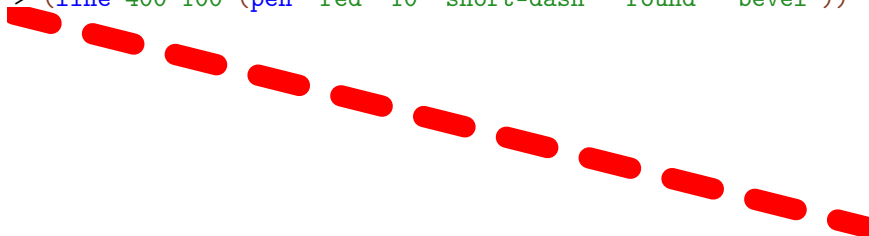

```
> (line 400 100 (pen "red" 10 "long-dash" "butt" "bevel"))
```

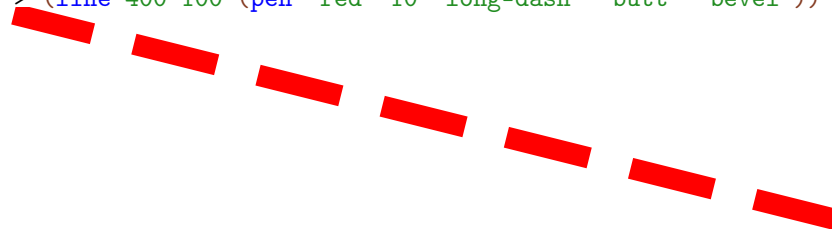

```
> (line 400 100 (pen "red" 10 "dot-dash" "butt" "bevel"))
```

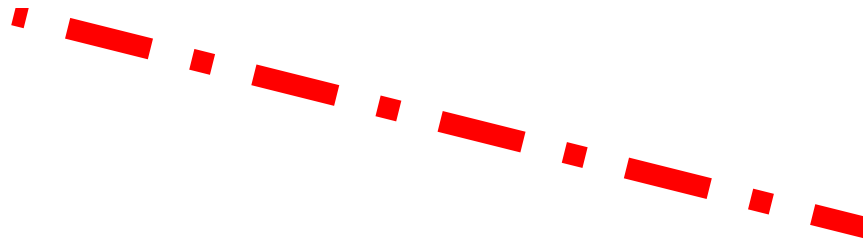

```
> (line 400 100 (pen "red" 30 "dot-dash" "butt" "bevel"))
```



```
(pen-style? x) → boolean?  
x : any/c
```

Determines if x is a valid pen style. It can be one of "solid", 'solid, "dot", 'dot, "long-dash", 'long-dash, "short-dash", 'short-dash, "dot-dash", or 'dot-dash.

```
(pen-cap? x) → boolean?  
x : any/c
```

Determines if x is a valid pen cap. It can be one of "round", 'round, "projecting", 'projecting, "butt", or 'butt.

```
(pen-join? x) → boolean?  
x : any/c
```

Determines if x is a valid pen join. It can be one of "round", 'round, "bevel", 'bevel, "miter", or 'miter.

2.3.9 Equality Testing of Images

Two images are `equal?` if they draw exactly the same way at their current size (not necessarily at all sizes) and, if there are pinholes, the pinholes are in the same place.

This can lead to some counter-intuitive results. For example, two completely different shapes that are the same size and are drawn with the transparent color are equal:

Example:

```
> (equal? (circle 30 "solid" "transparent")
          (square 60 "solid" "transparent"))
#t
```

See also §2.2.8 “The Nitty Gritty of Alpha Blending”.

2.3.10 Pinholes

A pinhole is an optional property of an image that identifies a point somewhere in the image. The pinhole can then be used to facilitate overlaying images by lining them up on their pinholes.



When an image has a pinhole, the pinhole is drawn with crosshairs on the image. The crosshairs are drawn with two one-pixel wide black lines (one horizontal and one vertical) and two one-pixel wide white lines, where the black lines is drawn .5 pixels to the left and above the pinhole, and the white lines are drawn .5 pixels to the right and below the pinhole. Accordingly, when the pixel is on an integral coordinate, then black and white lines all take up a single pixel and in the center of their intersections is the actual pinholes. See §2.2.7 “The Nitty Gritty of Pixels, Pens, and Lines” for more details about pixels.

When images are `overlay`'d, `underlay`'d (or the variants of those functions), placed `beside`, or `above` each other, the pinhole of the resulting image is the pinhole of the first image argument passed to the combining operation. When images are combined with `place-image` (or the variants of `place-image`), then the scene argument's pinhole is preserved.

```
(center-pinhole image) → image?
image : image?
```

Creates a pinhole in *image* at its center.

Examples:

```
> (center-pinhole (rectangle 40 20 "solid" "red"))

> (rotate 30 (center-pinhole (rectangle 40 20 "solid" "orange")))

```

```
(put-pinhole x y image) → image?
x : integer?
y : integer?
image : image?
```

Creates a pinhole in *image* at the point (*x*,*y*).

Example:

```
> (put-pinhole 2 18 (rectangle 40 20 "solid" "forestgreen"))  

```

```
(pinhole-x image) → (or/c integer? #f)  
image : image?
```

Returns the x coordinate of *image*'s pinhole.

Example:

```
> (pinhole-x (center-pinhole (rectangle 10 10 "solid" "red")))  
5
```

```
(pinhole-y image) → (or/c integer? #f)  
image : image?
```

Returns the y coordinate of *image*'s pinhole.

Example:

```
> (pinhole-y (center-pinhole (rectangle 10 10 "solid" "red")))  
5
```

```
(clear-pinhole image) → image?  
image : image?
```

Removes a pinhole from *image* (if the image has a pinhole).

```
(overlay/pinhole i1 i2 is ...) → image?  
i1 : image?  
i2 : image?  
is : image?
```

Overlays all of the image arguments on their pinholes. If any of the arguments do not have pinholes, then the center of the image is used instead.

Examples:

```
> (overlay/pinhole
  (put-pinhole 25 10 (ellipse 100 50 "solid" "red"))
  (put-pinhole 75 40 (ellipse 100 50 "solid" "blue")))
```

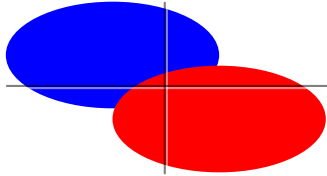

```
> (let ([petal (put-pinhole
                20 20
                (ellipse 100 40 "solid" "purple"))])
  (clear-pinhole
   (overlay/pinhole
    (circle 30 "solid" "yellow")
    (rotate (* 60 0) petal)
    (rotate (* 60 1) petal)
    (rotate (* 60 2) petal)
    (rotate (* 60 3) petal)
    (rotate (* 60 4) petal)
    (rotate (* 60 5) petal))))
```

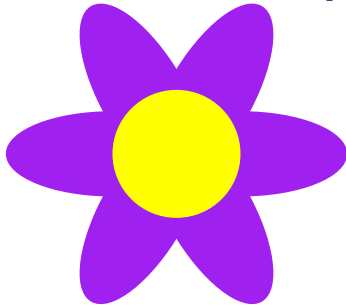

```
(underlay/pinhole i1 i2 is ...) → image?
  i1 : image?
  i2 : image?
  is : image?
```

Underlays all of the image arguments on their pinholes. If any of the arguments do not have pinholes, then the center of the image is used instead.

Examples:

```
> (underlay/pinhole
  (put-pinhole 25 10 (ellipse 100 50 "solid" "red"))
  (put-pinhole 75 40 (ellipse 100 50 "solid" "blue")))
```

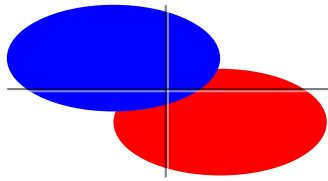

```
> (let* ([t (triangle 40 "solid" "orange")]
         [w (image-width t)]
         [h (image-height t)])
  (clear-pinhole
   (overlay/pinhole
    (put-pinhole (/ w 2) 0 t)
    (put-pinhole w h t)
    (put-pinhole 0 h t))))
```

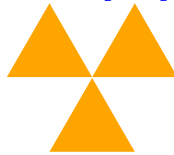

2.3.11 Exporting Images to Disk

In order to use an image as an input to another program (e.g., Photoshop or a web browser), it is necessary to represent it in a format that these programs can understand.

The `save-image` function provides this functionality, writing an image to disk using the PNG format. Since this format represents an image using a set of pixel values, an image written to disk generally contains less information than the image that was written, and cannot be scaled or manipulated as cleanly (by any image program).

The `save-svg-image` function writes an SVG file format representation of the file to the disk that, unlike `save-image` produces an image that can still be scaled arbitrarily look as good as scaling the image directly via `scale`.

```
(save-image image filename [width height]) → boolean?
  image : image?
  filename : path-string?
  width : (and/c real? (not/c negative?)) = (image-width image)
  height : (and/c real? (not/c negative?))
           = (image-height image)
```

Writes an image to the path specified by `filename`, using the PNG format.

The last two arguments are optional. If present, they determine the width and height of the save image file. If absent, the width and height of the image is used.

```
(save-svg-image image filename [width height]) → void?
  image : image?
  filename : path-string?
  width : (and/c real? (not/c negative?)) = (image-width image)
  height : (and/c real? (not/c negative?))
           = (image-height image)
```

Writes an image to the path specified by *filename*, using the SVG format.

The last two arguments are optional. If present, they determine the width and height of the save image file. If absent, the width and height of the image is used.

2.4 Worlds and the Universe: "universe.rkt"

```
(require 2htdp/universe)    package: htdp-lib
```

The `universe.rkt` teachpack implements and provides the functionality for creating interactive, graphical programs that consist of plain mathematical functions. We refer to such programs as *world* programs. In addition, world programs can also become a part of a *universe*, a collection of worlds that can exchange messages.

The purpose of this documentation is to give experienced Racketeers and HtDP teachers a concise overview for using the library. The first part of the documentation focuses on world programs. Section §2.4.4 “A First Sample World” presents an illustration of how to design such programs for a simple domain; it is suited for a novice who knows how to design conditional functions for enumerations, intervals, and unions. The second half of the documentation focuses on "universe" programs: how it is managed via a server, how world programs register with the server, etc. The last two sections show how to design a simple universe of two communicating worlds.

Note: For a quick and educational introduction to just worlds, see *How to Design Programs, Second Edition: Prologue*. As of August 2008, we also have a series of projects available as a small booklet on *How to Design Worlds*.

2.4.1 Background

The universe teachpack assumes working knowledge of the basic image manipulation operations, either `htdp/image` or `2htdp/image`. As far as this extended reference is concerned, the major difference between the two image teachpacks is the assumption that

`htdp/image` programs render their state as *scenes*, i.e., images that satisfy the `scene?` predicate.

Recall that `htdp/image` defines a scene to be an image whose pinhole is at (0,0). If your program uses the operations of `2htdp/image`, all images are also scenes.

While the operations of this teachpack work with both image teachpacks, we hope to eliminate `htdp/image` in the not-too-distant future. All example programs are already written using `2htdp/image` operations. We urge programmers to use `2htdp/image` when they design new “world” and “universe” programs and to rewrite their existing `htdp/image` programs to use `2htdp/image`.

2.4.2 Simple Simulations

The simplest kind of animated world program is a time-based simulation, which is a series of images. The programmer’s task is to supply a function that creates an image for each natural number. Handing this function to the teachpack displays the simulation.

```
(animate create-image) → natural-number/c
  create-image : (-> natural-number/c scene?)
```

opens a canvas and starts a clock that ticks 28 times per second. Every time the clock ticks, DrRacket applies `create-image` to the number of ticks passed since this function call. The results of these function calls are displayed in the canvas. The simulation runs until you click the Stop button in DrRacket or close the window. At that point, `animate` returns the number of ticks that have passed.

See §2.4.1
“Background” for
`scene?`.

Example:

```
(define (create-UFO-scene height)
  (underlay/xy (rectangle 100 100 "solid" "white") 50 height UFO))

(define UFO
  (underlay/align "center"
                 "center"
                 (circle 10 "solid" "green")
                 (rectangle 40 4 "solid" "green")))

(animate create-UFO-scene)
```

```
(run-simulation create-image) → natural-number/c
  create-image : (-> natural-number/c scene?)
```

`animate` was originally called `run-simulation`, and this binding is retained for backwards compatibility

See §2.4.1
“Background” for
`scene?`.

```
(run-movie r m) → [Listof image?]
  r : (and/c real? positive?)
  m : [Listof image?]
```

`run-movie` displays the list of images m , spending r seconds per image. When the animation is stopped, a list of the remaining, undisplayed images are returned.

2.4.3 Interactions

The step from simulations to interactive programs is relatively small. Roughly speaking, a simulation designates one function, `create-image`, as a handler for one kind of event: clock ticks. In addition to clock ticks, world programs can also deal with two other kinds of events: keyboard events and mouse events. A keyboard event is triggered when a computer user presses a key on the keyboard. Similarly, a mouse event is the movement of the mouse, a click on a mouse button, the crossing of a boundary by a mouse movement, etc.

Your program may deal with such events via the *designation of handler functions*. Specifically, the teachpack provides for the installation of four event handlers: `on-tick`, `on-key`, `on-mouse`, and `on-pad`. In addition, a world program must specify a `render` function, which is called every time your program should visualize the current world, and a `done` predicate, which is used to determine when the world program should shut down.

Each handler function consumes the current state of the world and optionally a data representation of the event. It produces a new state of the world.

The following picture provides an intuitive overview of the workings of a world program in the form of a state transition diagram.

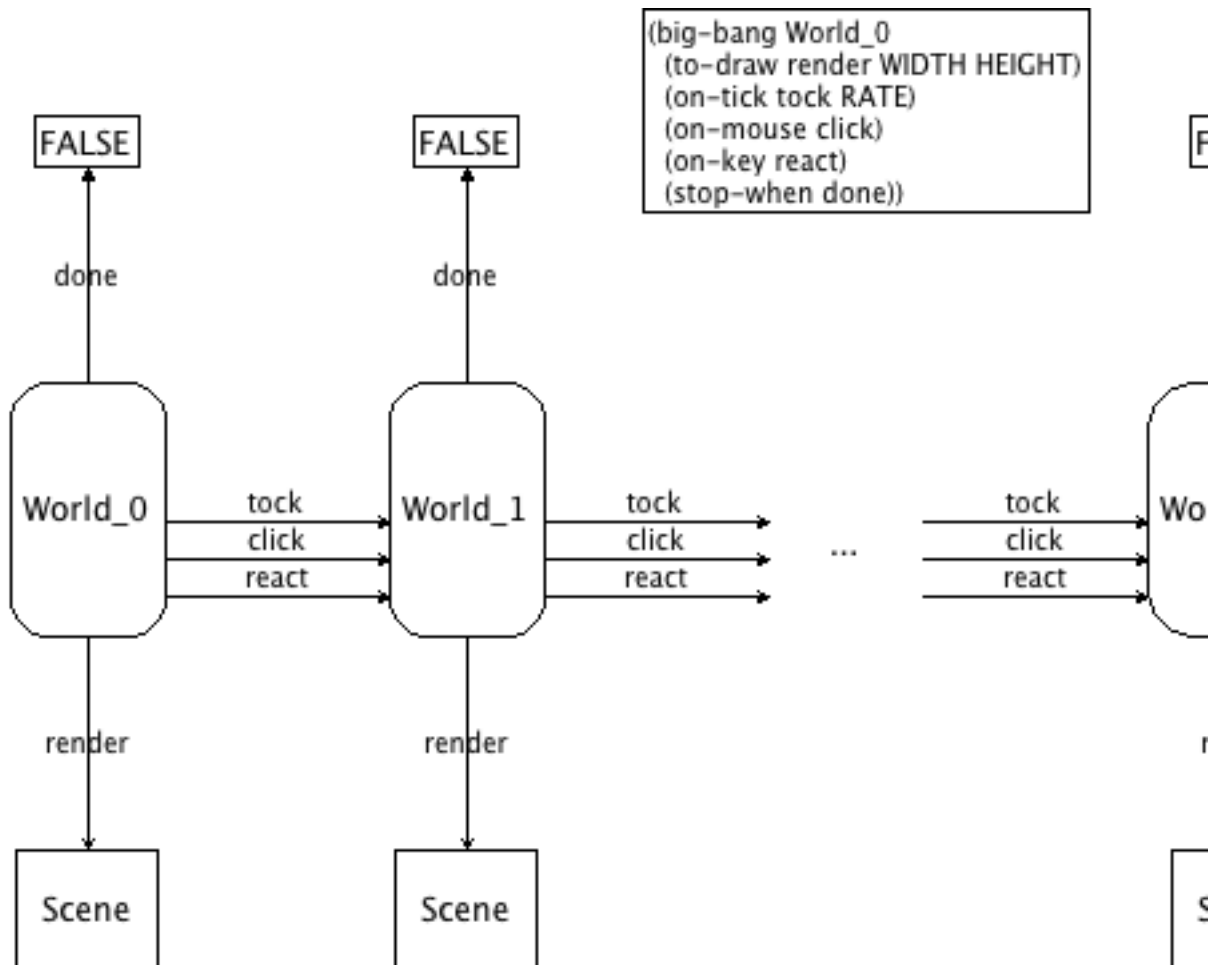

The big-bang form installs `World_0` as the initial `WorldState`. The handlers `tock`, `react`, and `click` transform one world into another one; each time an event is handled, `done` is used to check whether the world is final, in which case the program is shut down; and finally, `render` renders each world as an image, which is then displayed on an external canvas.

`WorldState` : `any/c`

The design of a world program demands that you come up with a data definition of all possible states. We use `WorldState` to refer to this collection of data, using a capital `W` to distinguish it from the program. In principle, there are no constraints on this data definition though it mustn't be an instance of the `Package` structure (see below). You can even keep it

implicit, even if this violates the Design Recipe.

```
(big-bang state-expr clause ...)  
  
clause = (on-tick tick-expr)  
         | (on-tick tick-expr rate-expr)  
         | (on-tick tick-expr rate-expr limit-expr)  
         | (on-key key-expr)  
         | (on-pad pad-expr)  
         | (on-release release-expr)  
         | (on-mouse mouse-expr)  
         | (to-draw draw-expr)  
         | (to-draw draw-expr width-expr height-expr)  
         | (stop-when stop-expr)  
         | (stop-when stop-expr last-scene-expr)  
         | (check-with world?-expr)  
         | (record? r-expr)  
         | (close-on-stop cos-expr)  
         | (display-mode d-expr)  
         | (state expr)  
         | (on-receive rec-expr)  
         | (register IP-expr)  
         | (port Port-expr)  
         | (name name-expr)
```

starts a world program in the initial state specified with *state-expr*, which must of course evaluate to an element of `WorldState`. Its behavior is specified via the handler functions designated in the optional clauses, especially how the world program deals with clock ticks, with key events, with mouse events, and eventually with messages from the universe; how it renders itself as an image; when the program must shut down; where to register the world with a universe; and whether to record the stream of events. A world specification may not contain more than one `on-tick`, `to-draw`, or `register` clause. A `big-bang` expression returns the last world when the stop condition is satisfied (see below) or when the programmer clicks on the Stop button or closes the canvas.

The only mandatory clause of a `big-bang` description is `to-draw` (or `on-draw` for backwards compatibility):

```
• (to-draw render-expr)  
  render-expr : (-> WorldState scene?)
```

tells DrRacket to call the function *render-expr* whenever the canvas must be drawn.

See §2.4.1
“Background” for
`scene?`.

The external canvas is usually re-drawn after DrRacket has dealt with an event. Its size is determined by the size of the first generated image.

```
(to-draw render-expr width-expr height-expr)  
  
render-expr : (-> WorldState scene?)  
width-expr : natural-number/c  
height-expr : natural-number/c
```

tells DrRacket to use a *width-expr* by *height-expr* canvas instead of one determined by the first generated image.

See §2.4.1
“Background” for
scene?.

For compatibility reasons, the teachpack also supports the keyword `on-draw` in lieu of `to-draw` but the latter is preferred now.

All remaining clauses are optional. To introduce them, we need one more data definition:

HandlerResult : is a synonym for *WorldState* until §2.4.5 “The World is not Enough”

- ```
(on-tick tick-expr)

tick-expr : (-> WorldState HandlerResult)
```

tells DrRacket to call the *tick-expr* function on the current world every time the clock ticks. The result of the call becomes the current world. The clock ticks at the rate of 28 times per second.

- ```
(on-tick tick-expr rate-expr)  
  
tick-expr : (-> WorldState HandlerResult)  
rate-expr : (and/c real? positive?)
```

tells DrRacket to call the *tick-expr* function on the current world every time the clock ticks. The result of the call becomes the current world. The clock ticks every *rate-expr* seconds.

- ```
(on-tick tick-expr rate-expr limit-expr)

tick-expr : (-> WorldState HandlerResult)
rate-expr : (and/c real? positive?)
limit-expr : (and/c integer? positive?)
```

tells DrRacket to call the *tick-expr* function on the current world every time the clock ticks. The result of the call becomes the current world. The clock ticks every *rate-expr* seconds. The world ends when the clock has ticked more than *limit-expr* times.

- A KeyEvent represents key board events.

*KeyEvent* : `string?`

For simplicity, we represent key events with strings, but not all strings are key events. The representation of key events comes in distinct classes. First, a single-character string is used to signal that the user has hit a "regular" key, such as

- "q" stands for the q key;
- "w" stands for the w key;
- "e" stands for the e key;
- "r" stands for the r key; and so on.

Some of these one-character strings look somewhat unusual:

- " " stands for the space bar (`#\space`);
- "\r" stands for the return and enter key (`#\return`);
- "\t" stands for the tab key (`#\tab`); and
- "\b" stands for the backspace key (`#\backspace`).

Here is "proof" that these strings really have length 1:

```
> (string-length "\t")
1
```

On rare occasions your programs may also encounter `"\u007F"`, which is the string representing the delete key (aka rubout).

Second, some keys have multiple-character string representations. Strings with more than one character denote arrow keys or other special events, starting with the four most important ones:

- "left" is the left arrow;
- "right" is the right arrow;
- "up" is the up arrow;
- "down" is the down arrow;

Here are some others that you may encounter:

- "start"
- "cancel"

- "clear"
- "shift"
- "rshift"
- "control"
- "rcontrol"
- "menu"
- "pause"
- "capital"
- "prior"
- "next"
- "end"
- "home"
- "escape"
- "select"
- "print"
- "execute"
- "snapshot"
- "insert"
- "help"
- function keys: "f1", "f2", "f3", "f4", "f5", "f6", "f7", "f8", "f9", "f10", "f11", "f12", "f13", "f14", "f15", "f16", "f17", "f18", "f19", "f20", "f21", "f22", "f23", "f24"
- "numlock"
- "scroll"

The following four count as keyevents even though they are triggered by physical events on some form of mouse:

- "wheel-up"
- "wheel-down"
- "wheel-left"
- "wheel-right"

The preceding enumeration is neither complete in covering all the events that this library deals with nor does it specify which events the library ignores. If you wish to design a program that relies on specific keys on your keyboard, you should first write a small test program to find out whether the chosen keystrokes are caught by the library and, if so, which string representations are used for these events.

```
(key-event? x) → boolean?
 x : any
```

determines whether *x* is a KeyEvent

```
(key=? x y) → boolean?
 x : key-event?
 y : key-event?
```

compares two KeyEvent for equality

```
(on-key key-expr)

 key-expr : (-> WorldState key-event? HandlerResult)
```

tells DrRacket to call the *key-expr* function on the current world and a KeyEvent for every keystroke the user of the computer makes. The result of the call becomes the current world.

Here is a typical key-event handler:

```
(define (change w a-key)
 (cond
 [(key=? a-key "left") (world-go w -DELTA)]
 [(key=? a-key "right") (world-go w +DELTA)]
 [(= (string-length a-key) 1) w] ; order-free checking
 [(key=? a-key "up") (world-go w -DELTA)]
 [(key=? a-key "down") (world-go w +DELTA)]
 [else w]))
```

The omitted, auxiliary function *world-go* is supposed to consume a world and a number and produces a world.

```
(on-release release-expr)

 release-expr : (-> WorldState key-event? HandlerResult)
```

tells DrRacket to call the *release-expr* function on the current world and a KeyEvent for every release event on the keyboard. A release event occurs when a user presses the key and then releases it. The second argument indicates which key has been released. The result of the function call becomes the current world.

- A PadEvent is a KeyEvent for a game-pad simulation via big-bang. The presence of an on-pad clause superimposes the game-pad image onto the current image, suitably scaled to its size:



*PadEvent* : [key-event?](#)

It is one of the following:

- "left" is the left arrow;
- "right" is the right arrow;
- "up" is the up arrow;
- "down" is the down arrow;
- "w" to be interpreted as up arrow;
- "s" to be interpreted as down arrow;
- "a" to be interpreted as left arrow;
- "d" to be interpreted as right arrow;
- " " is the space bar;
- "shift" is the left shift key;
- "rshift" is the right shift key;

```
(pad-event? x) → boolean?
x : any
```

determines whether *x* is a PadEvent

```
(pad=? x y) → boolean?
x : pad-event?
y : pad-event?
```

compares two PadEvent for equality

```
(on-pad pad-expr)

pad-expr : (-> WorldState pad-event? HandlerResult)
```

tells DrRacket to call the *pad-expr* function on the current world and the KeyEvent for every keystroke that is also a PadEvent. The result of the call becomes the current world.

Here is a typical PadEvent handler:

```

; ComplexNumber PadEvent -> ComplexNumber
(define (handle-pad-events x k)
 (case (string->symbol k)
 [(up w) (- x 0+10i)]
 [(down s) (+ x 0+10i)]
 [(left a) (- x 10)]
 [(right d) (+ x 10)]
 [(| |) x0]
 [(shift) (conjugate x)]
 [(rshift) (stop-with (conjugate x))]))

```

When a big-bang expression specifies an on-pad clause, all PadEvents are sent to the on-pad handler. All other key events are discarded, unless an on-key and/or an on-release clause are specified, in which case all remaining KeyEvents are sent there.

To facilitate the definition of on-pad handlers, the library provides the pad-handler form.

```

(pad-handler clause ...)

clause = (up up-expr)
 | (down down-expr)
 | (left left-expr)
 | (right right-expr)
 | (space space-expr)
 | (shift shift-expr)

```

Creates a function that deals with PadEvents. Each (optional) clause contributes one function that consumes a World and produces a world. The name of the clause determines for which kind of PadEvent the function is called.

Using the form is entirely optional and not required to use on-pad. Indeed, pad-handler could be used to define a plain KeyEvent handler—if we could guarantee that players never hit keys other than PadEvent keys.

All clauses in a pad-handler form are optional:

```

- | (up up-expr)
 |
 | tick-expr : (-> WorldState HandlerResult)

```

Creates a handler for "up" and "w" events.

```

- | (down down-expr)
 |
 | tick-expr : (-> WorldState HandlerResult)

```

Creates a handler for "down" and "s" events.

```

- | (left left-expr)
 | tick-expr : (-> WorldState HandlerResult)

```

Creates a handler for "left" and "a" events.

```

- | (right right-expr)
 | tick-expr : (-> WorldState HandlerResult)

```

Creates a handler for "right" and "d" events.

```

- | (space space-expr)
 | tick-expr : (-> WorldState HandlerResult)

```

Creates a handler for space-bar events (" ").

```

- | (shift shift-expr)
 | tick-expr : (-> WorldState HandlerResult)

```

Creates a handler for "shift" and "rshift" events.

If a clause is omitted, pad-handler installs a default function that maps the existing world to itself.

Here is a PadEvent handler defined with pad-handler:

```

; ComplexNumber -> ComplexNumber
(define (i-sub1 x) (- x 0+1i))

; ComplexNumber -> ComplexNumber
(define (i-add1 x) (+ x 0+1i))

; ComplexNumber -> ComplexNumber
; deal with all PadEvents
(define handler
 (pad-handler (left sub1) (right add1)
 (up i-sub1) (down i-add1)
 (shift (lambda (w) 0))
 (space stop-with)))

; some tests:
(check-expect (handler 9 "left") 8)
(check-expect (handler 8 "up") 8-1i)

```

- A `MouseEvent` represents mouse events, e.g., mouse movements or mouse clicks, by the computer's user.

```
MouseEvent : (one-of/c "button-down" "button-up" "drag" "move" "enter" "leave")
```

All `MouseEvent`s are represented via strings:

- "button-down" signals that the computer user has pushed a mouse button down;
- "button-up" signals that the computer user has let go of a mouse button;
- "drag" signals that the computer user is dragging the mouse. A dragging event occurs when the mouse moves while a mouse button is pressed.
- "move" signals that the computer user has moved the mouse;
- "enter" signals that the computer user has moved the mouse into the canvas area; and
- "leave" signals that the computer user has moved the mouse out of the canvas area.

```
(mouse-event? x) → boolean?
x : any
```

determines whether `x` is a `MouseEvent`

```
(mouse=? x y) → boolean?
x : mouse-event?
y : mouse-event?
```

compares two `MouseEvent`s for equality

```
(on-mouse mouse-expr)
 (-> WorldState
mouse-expr : integer? integer? MouseEvent
 HandlerResult)
```

tells DrRacket to call `mouse-expr` on the current world, the current `x` and `y` coordinates of the mouse, and a `MouseEvent` for every (noticeable) action of the mouse by the computer user. The result of the call becomes the current world.

For "leave" and "enter" events, the coordinates of the mouse click may be outside of the (implicit) rectangle. That is, the coordinates may be negative or larger than the (implicitly) specified width and height.

**Note 1:** the operating system doesn't really notice every single movement of the mouse (across the mouse pad). Instead it samples the movements and signals most of them.

**Note 2:** while mouse events are usually reported in the expected manner, the operating system doesn't necessarily report them in the expected order. For example, the Windows operating system insists on signaling a "move" event immediately after a "button-up" event is discovered. Programmers must design the on-mouse handler to handle any possible mouse event at any moment.

- ```
(stop-when last-world?)  
  
last-world? : (-> WorldState boolean?)
```

tells DrRacket to call the `last-world?` function at the start of the world program and after any other world-producing callback. If this call produces `#true`, the world program is shut down. Specifically, the clock is stopped; no more tick events, KeyEvents, or MouseEvents are forwarded to the respective handlers. The big-bang expression returns this last world.

```
(stop-when last-world? last-picture)  
  
last-world? : (-> WorldState boolean?)  
last-picture : (-> WorldState scene?)
```

tells DrRacket to call the `last-world?` function at the start of the world program and after any other world-producing callback. If this call produces `#true`, the world program is shut down after displaying the world one last time, this time using the image rendered with `last-picture`. Specifically, the clock is stopped; no more tick events, KeyEvents, or MouseEvents are forwarded to the respective handlers. The big-bang expression returns this last world.

See §2.4.1
"Background" for
`scene?`.

- ```
(struct stop-with (w))
w : HandlerResult
```

signals to DrRacket that the world program should shut down. That is, any handler may return `(stop-with w)` provided `w` is a `HandlerResult`. If it does, the state of the world becomes `w` and big-bang will close down all event handling. Similarly, if the initial state of the world is `(stop-with w)`, event handling is immediately closed down.

- ```
(check-with world-expr?)  
  
world-expr? : (-> Any boolean?)
```

tells DrRacket to call the `world-expr?` function on the result of every world handler call. If this call produces `#true`, the result is considered a world; otherwise the world program signals an error.

- ```
(record? r-expr)
r-expr : any/c
```

tells DrRacket to enable a visual replay of the interaction, unless `#f`. The replay action generates one png image per image and an animated gif for the entire sequence in the directory of the user's choice. If `r-expr` evaluates to the name of an existing directory/folder (in the local directory/folder), the directory is used to deposit the images.

- ```
(close-on-stop cos-expr)
cos-expr : (or/c boolean? natural-number/c)
```

tells DrRacket whether to close the big-bang window *after* the expression is evaluated. If `cos-expr` is `#true`, which is the default, the window closes immediately. If `cos-expr` is `#false`, the window remains open for a long time. Finally, if `cos-expr` is a natural number, the window closes `cos-expr` seconds after the big-bang expression is evaluated.

- ```
(display-mode d-expr)
d-expr : (or/c 'fullscreen 'normal)
```

informs DrRacket to choose one of two display modes: `'normal` or `'fullscreen`. The `'normal` mode is the default and uses the size specifications from the `to-draw` clause. If the `'fullscreen` mode is specified, big-bang takes over the full screen.

- ```
(display-mode d-expr resize-expr)
d-expr : (or/c 'fullscreen 'normal)
resize-expr : (-> WorldState number? number? WorldState)
```

informs DrRacket to choose one of two display modes: `'normal` or `'fullscreen`. The `'normal` mode is the default and uses the size specifications from the `to-draw` clause. If the `'fullscreen` mode is specified, big-bang takes over the full screen.

The optional `resize-expr` is applied to the current world and the sizes (width and height) of the display **once**, when the world is initialized. This gives the program a chance to draw shapes of a size relative to the display size in a portable manner.

- ```
(state expr)
```

if not `#f`, DrRacket opens two separate windows:

- one shows the current state each time it is updated.
- another that displays the events and the related event data.

This is useful for beginners who wish to see how their world evolves and why—without having to design a rendering function.

- ```
(name name-expr)
  name-expr : (or/c symbol? string?)
```

provide a name (*name-expr*) to this world, which is used as the title of the canvas.

The following example shows that `(run-simulation create-UFO-scene)` is a shorthand for three lines of code:

```
(define (create-UFO-scene height)
  (underlay/xy (rectangle 100 100 "solid" "white") 50 height UFO))

(define UFO
  (underlay/align "center"
                 "center"
                 (circle 10 "solid" "green")
                 (rectangle 40 4 "solid" "green")))

(big-bang 0
  (on-tick add1)
  (to-draw create-UFO-scene))
```

Exercise Add a condition for stopping the flight of the UFO when it reaches the bottom.

2.4.4 A First Sample World

This section uses a simple example to explain the design of worlds. The first subsection introduces the sample domain, a door that closes automatically. The second subsection is about the design of world programs in general, the remaining subsections implement a simulation of the door.

Understanding a Door

Say we wish to design a world program that simulates the working of a door with an automatic door closer. If this kind of door is locked, you can unlock it with a key. While this doesn't open the door per se, it is now possible to do so. That is, an unlocked door is closed

and pushing at the door opens it. Once you have passed through the door and you let go, the automatic door closer takes over and closes the door again. When a door is closed, you can lock it again.

Here is a diagram that translates our words into a graphical representation:

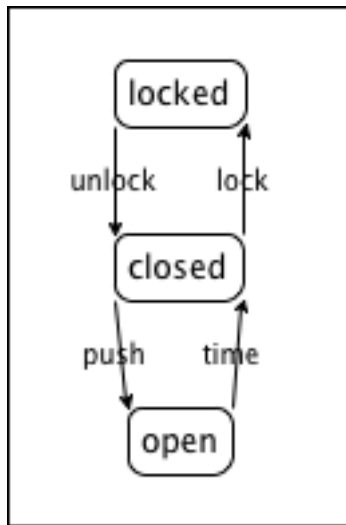

Like the picture of the general workings of a world program, this diagram displays a so-called “state machine.” The three circled words are the states that our informal description of the door identified: locked, closed (and unlocked), and open. The arrows specify how the door can go from one state into another. For example, when the door is open, the automatic door closer shuts the door as time passes. This transition is indicated by the arrow labeled “time.” The other arrows represent transitions in a similar manner:

- “push” means a person pushes the door open (and let’s go);
- “lock” refers to the act of inserting a key into the lock and turning it to the locked position; and
- “unlock” is the opposite of “lock.”

Hints on Designing Worlds

Simulating any dynamic behavior via a world program demands two different activities. First, we must tease out those portions of our domain that change over time or in reaction to actions, and we must develop a data representation for this information. This is what we call WorldState. Keep in mind that a good data definition makes it easy for readers to map data to information in the real world and vice versa. For all others aspects of the world, we use global constants, including graphical or visual constants that are used in conjunction with the rendering operations.

Second, we must translate the actions in our domain—the arrows in the above diagram—into interactions with the computer that the universe teachpack can deal with. Once we have decided to use the passing of time for one aspect, key presses for another, and mouse movements for a third, we must develop functions that map the current state of the world—represented as data from `WorldState`—into the next state of the world. Put differently, we have just created a wish list with three handler functions that have the following general contract and purpose statements:

```
; tick : WorldState -> HandlerResult
; deal with the passing of time
(define (tick w) ...)

; click : WorldState Number Number MouseEvent -> HandlerResult
; deal with a mouse click at (x,y) of kind me
; in the current world w
(define (click w x y me) ...)

; control : WorldState KeyEvent -> HandlerResult
; deal with a key event ke
; in the current world w
(define (control w ke) ...)
```

That is, the contracts of the various handler designations dictate what the contracts of our functions are, once we have defined how to represent the domain with data in our chosen language.

A typical program does not use all three of these functions. Furthermore, the design of these functions provides only the top-level, initial design goal. It often demands the design of many auxiliary functions. The collection of all these functions is your world program.

An extended example is available in [How to Design Programs/2e](#).

2.4.5 The World is not Enough

The library facilities covered so far are about designing individual programs with interactive graphical user interfaces (simulations, animations, games, etc.). In this section, we introduce capabilities for designing a distributed program, which is really a number of programs that coordinate their actions in some fashion. Each of the individual programs may run on any computer in the world (as in our planet and the spacecrafts that we sent out), as long as it is on the internet and as long as the computer allows the program to send and receive messages (via TCP). We call this arrangement a universe and the program that coordinates it all a *universe server* or just server.

This section explains what messages are, how to send them from a world program, how to receive them, and how to connect a world program to a universe.

Messages

After a world program has become a part of a universe, it may send messages and receive them. In terms of data, a message is just an S-expression.

S-expression An S-expression is roughly a nested list of basic data; to be precise, an S-expression is one of:

- a string,
- a symbol,
- a number,
- a boolean,
- a char, or
- a list of S-expressions,
- a prefab struct of S-expressions, or
- a byte string.

Note the `list` clause includes `empty` of course.

```
(sexp? x) → boolean?  
x : any/c
```

determines whether `x` is an S-expression.

Sending Messages

Each world-producing callback in a world program—those for handling clock tick events, keyboard events, and mouse events—may produce a `Package` in addition to just a `WorldState`:

HandlerResult is one of the following:

- `WorldState`
- `Package`

where *Package* represents a pair consisting of a `WorldState` and a message from a world program to the server. Because programs only send messages via `Package`, the teachpack does not provide the selectors for the structure, only the constructor and a predicate.

```
(package? x) → boolean?  
x : any/c
```

determine whether x is a Package.

```
(make-package w m) → package?  
w : any/c  
m : sexp?
```

create a Package from a WorldState and an S-expression.

Recall that event handlers return a HandlerResult, and we have just refined this data definition. Hence, each handler may return either a WorldState or a Package. If an event handler produces a Package, the content of the world field becomes the next world and the message field specifies what the world sends to the universe. This distinction also explains why the data definition for WorldState may not include a Package.

Connecting with the Universe

Messages are sent to the universe program, which runs on some computer in the world. The next section is about constructs for creating such a universe server. For now, we just need to know that it exists and that it is the recipient of messages.

IP string?

Before a world program can send messages, it must register with the server. Registration must specify the internet address of the computer on which the server runs, also known as an IP address or a host. Here a IP address is a string of the right shape, e.g., "192.168.1.1" or "www.google.com".

```
LOCALHOST : string?
```

the IP of your computer. Use it while you are developing a distributed program, especially while you are investigating whether the participating world programs collaborate in an appropriate manner. This is called *integration testing* and differs from unit testing quite a bit.

A big-bang description of a world program that wishes to communicate with other programs must contain a `register` clause of one of the following shapes:

- ```
(register ip-expr)
ip-expr : string?
```

connect this world to a universe server at the specified *ip-expr* address and set up capabilities for sending and receiving messages. If the world description includes a

name specification of the form `(name SomeString)` or `(name SomeSymbol)`, the name of the world is sent along to the server.

- ```
(port port-expr)
  port-expr : natural-number/c
```

specifies port on which a world wishes to receive and send messages. A port number is an integer between 0 and 65536.

When a world program registers with a universe program and the universe program stops working, the world program stops working, too.

Receiving Messages

Finally, the receipt of a message from the server is an event, just like tick events, keyboard events, and mouse events. Dealing with the receipt of a message works exactly like dealing with any other event. DrRacket applies the event handler that the world program specifies; if there is no clause, the message is discarded.

The `on-receive` clause of a `big-bang` specifies the event handler for message receipts.

```
(on-receive receive-expr)
  receive-expr : (-> WorldState sexp? HandlerResult)
```

tells DrRacket to call `receive-expr` for every message receipt, on the current `WorldState` and the received message. The result of the call becomes the current `WorldState`.

Because `receive-expr` is (or evaluates to) a world-transforming function, it too can produce a `Package` instead of just a `WorldState`. If the result is a `Package`, its message content is sent to the server.

The diagram below summarizes the extensions of this section in graphical form.

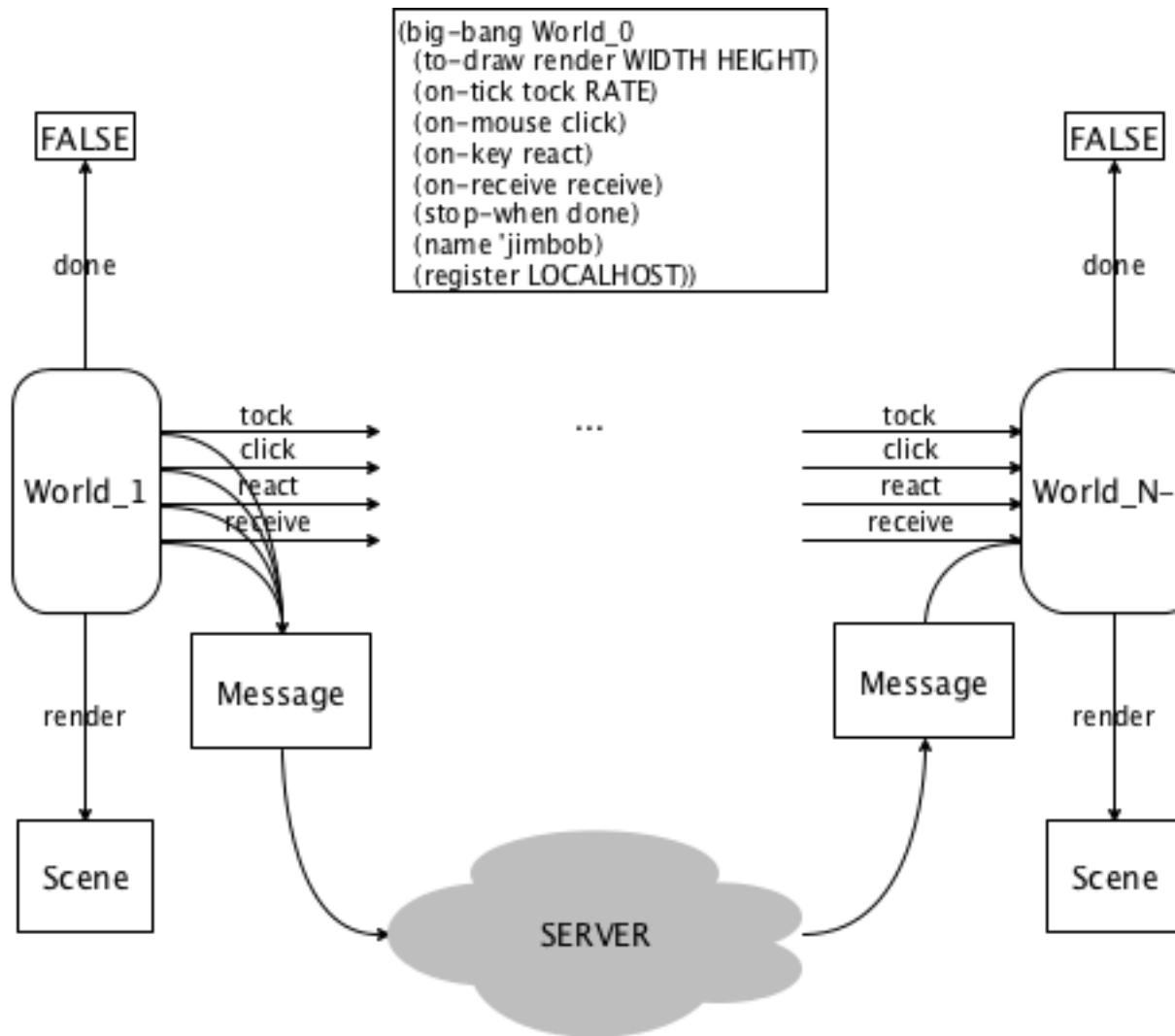

A registered world program may send a message to the universe server at any time by returning a Package from an event handler. The message is transmitted to the server, which may forward it to some other world program as given or in some massaged form. The arrival of a message is just another event that a world program must deal with. Like all other event handlers *receive* accepts a WorldState and some auxiliary arguments (a message in this case) and produces a WorldState or a Package.

When messages are sent from any of the worlds to the universe or vice versa, there is no need for the sender and receiver to synchronize. Indeed, a sender may dispatch as many messages as needed without regard to whether the receiver has processed them yet. The messages simply wait in queue until the receiving server or world program takes care of them.

2.4.6 The Universe Server

A *server* is the central control program of a universe and deals with receiving and sending of messages between the world programs that participate in the universe. Like a world program, a server is a program that reacts to events, though to different events than worlds. The two primary kinds of events are the appearance of a new world program in the universe and the receipt of a message from a world program.

The teachpack provides a mechanism for designating event handlers for servers that is quite similar to the mechanism for describing world programs. Depending on the designated event handlers, the server takes on distinct roles:

- A server may be a “pass through” channel between two worlds, in which case it has no other function than to communicate whatever message it receives from one world to the other, without any interference.
- A server may enforce a “back and forth” protocol, i.e., it may force two (or more) worlds to engage in a civilized tit-for-tat exchange. Each world is given a chance to send a message and must then wait to get a reply before it sends anything again.
- A server may play the role of a special-purpose arbiter, e.g., the referee or administrator of a game. It may check that each world “plays” by the rules, and it administrates the resources of the game.

As a matter of fact, a pass-through server can become basically invisible, making it appear as if all communication goes from peer world to peer in a universe.

This section first introduces some basic forms of data that the server uses to represent worlds and other matters. Second, it explains how to describe a server program.

Worlds and Messages

Understanding the server’s event handling functions demands several data representations: that of (a connection to) a world program and that of a response of a handler to an event.

- The server and its event handlers must agree on a data representation of the worlds that participate in the universe.

```
(iworld? x) → boolean?  
x : any/c
```

determines whether *x* is an *iworld*. Because the universe server represents worlds via structures that collect essential information about the connections, the teachpack does not export any constructor or selector functions on worlds.

```
(iworld=? u v) → boolean?
```

```
u : iworld?  
v : iworld?
```

compares two *iworlds* for equality.

```
(iworld-name w) → (or/c symbol? string?)  
w : iworld?
```

extracts the name from a *iworld* structure.

```
iworld1 : iworld?
```

an *iworld* for testing your programs

```
iworld2 : iworld?
```

another *iworld* for testing your programs

```
iworld3 : iworld?
```

and a third one

The three sample *iworlds* are provided so that you can test your functions for universe programs. For example:

```
(check-expect (iworld=? iworld1 iworld2) #false)  
(check-expect (iworld=? iworld2 iworld2) #true)
```

- Each event handler produces a state of the universe or a *bundle*, which is a structure that contains the server's state, a list of mails to other worlds, and the list of *iworlds* that are to be disconnected.

```
(bundle? x) → boolean?  
x : any/c
```

determines whether *x* is a *bundle*.

```
(make-bundle state mails low-to-remove) → bundle?  
state : any/c  
mails : (listof mail?)  
low-to-remove : (listof iworld?)
```

creates a *bundle* from a piece of data that represents a server state, a list of mails, and a list of *iworlds*.

The list of *iworlds* in the third field of the bundle are removed from the list of participants from which to expect messages.

If disconnecting from these worlds results in an empty list of participants, the universe server is restarted in the initial state.

A *mail* represents a message from an event handler to a world. The teachpack provides only a predicate and a constructor for these structures:

```
(mail? x) → boolean?  
x : any/c
```

determines whether *x* is a *mail*.

```
(make-mail to content) → mail?  
to : iworld?  
content : sexp?
```

creates a *mail* from a *iworld* and an S-expression.

Universe Descriptions

A server keeps track of information about the universe that it manages. One kind of tracked information is obviously the collection of participating world programs, but in general the kind of information that a server tracks and how the information is represented depends on the situation and the programmer, just as with world programs.

UniverseState : any/c

The design of a universe server demands that you come up with a data definition for all possible server states. For running universes, the teachpack demands that you come up with a data definition for (your state of the) server. Any piece of data can represent the state. We just assume that you introduce a data definition for the possible states and that your event handlers are designed according to the design recipe for this data definition.

The server itself is created with a description that includes the first state and a number of clauses that specify functions for dealing with universe events.

```
(universe state-expr clause ...)  
  
clause = (on-new new-expr)  
         | (on-msg msg-expr)  
         | (on-tick tick-expr)  
         | (on-tick tick-expr rate-expr)  
         | (on-tick tick-expr rate-expr limit-expr)  
         | (on-disconnect dis-expr)  
         | (state expr)  
         | (to-string render-expr)  
         | (port port-expr)  
         | (check-with universe?-expr)
```

creates a server with a given state, *state-expr*. The behavior is specified via handler functions through mandatory and optional *clauses*. These functions govern how the server deals with the registration of new worlds, how it disconnects worlds, how it sends messages

from one world to the rest of the registered worlds, and how it renders its current state as a string.

Evaluating a `universe` expression starts a server. Visually it opens a console window on which you can see that worlds join, which messages are received from which world, and which messages are sent to which world. Messages that are too long are truncated before they are displayed.

For convenience, the console also has two buttons: one for shutting down a universe and another one for re-starting it. The latter functionality is especially useful during the integration of the various pieces of a distributed program.

The mandatory clauses of a `universe` server description are `on-new` and `on-msg`:

- ```
(on-new new-expr)

 new-expr : (-> UniverseState iworld? (or/c UniverseState bundle?))
```

tells DrRacket to call the function `new-expr` every time another world joins the universe. The event handler is called with the current state and the joining `iworld`, which isn't on the list yet. In particular, the handler may reject a world program from participating in a universe, by simply returning the given state or by immediately including the new world in the third field of the resulting `bundle` structure.

Changed in version 1.1 of package `htdp-lib`: allow universe handlers to return a plain universe state

- ```
(on-msg msg-expr)  
  
  msg-expr : (-> UniverseState iworld? sexp? (or/c UniverseState bundle?))
```

tells DrRacket to apply `msg-expr` to the current state of the universe, the world `w` that sent the message, and the message itself.

Changed in version 1.1 of package `htdp-lib`: allow universe handlers to return a plain universe state

All proper event handlers produce a state of the universe or a `bundle`. The state of the universe is safe-guarded by the server until the next event, and the mails are broadcast as specified. The list of `iworlds` in the third field of the bundle are removed from the list of participants from which to expect messages.

The following picture provides a graphical overview of the server's workings.

```
(universe UniState_0
 (on-new sign-up)
 (on-msg process)
 (on-dis disconnect)
 (on-tick tock)
 (to-string render))
```

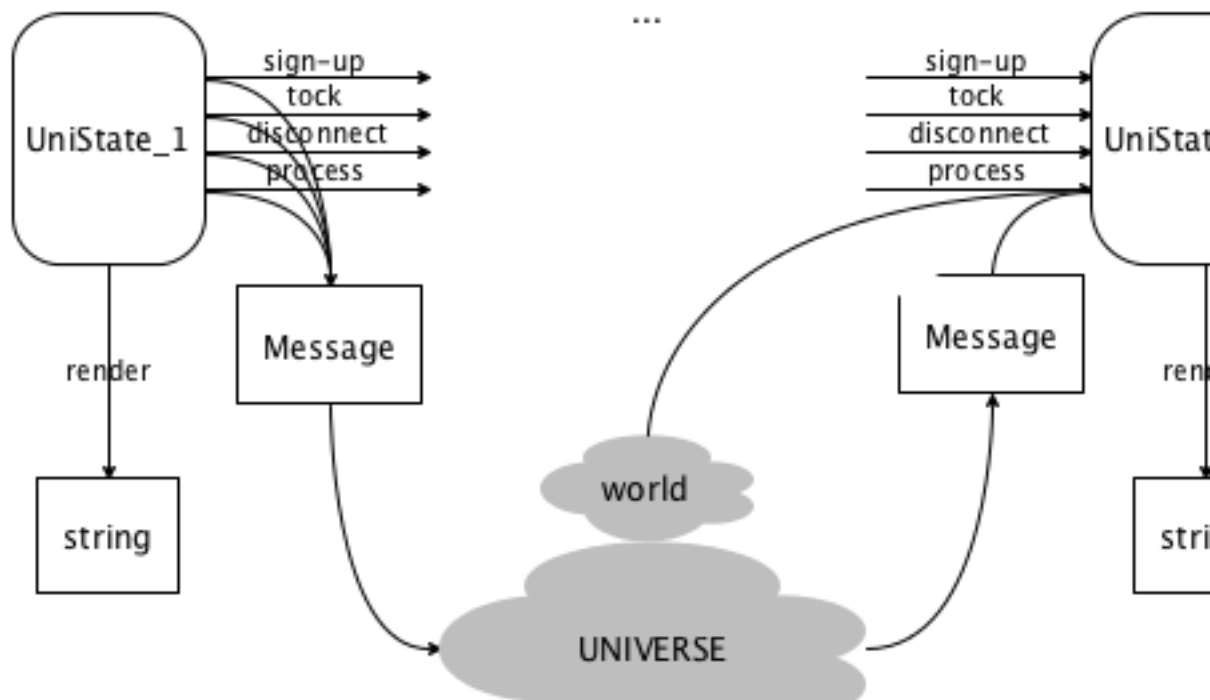

In addition to the mandatory handlers, a program may wish to add some optional handlers:

- ```
(on-tick tick-expr)
 tick-expr : (-> UniverseState (or/c UniverseState bundle?))
```

tells DrRacket to apply *tick-expr* to the current state of the universe.

Changed in version 1.1 of package `htdp-lib`: allow universe handlers to return a plain universe state

- ```
(on-tick tick-expr rate-expr)
```

```
tick-expr : (-> UniverseState (or/c UniverseState bundle?))
rate-expr : (and/c real? positive?)
```

tells DrRacket to apply *tick-expr* as above; the clock ticks every *rate-expr* seconds.

Changed in version 1.1 of package `htdp-lib`: allow universe handlers to return a plain universe state

```
(on-tick tick-expr rate-expr limit-expr)

tick-expr : (-> UniverseState (or/c UniverseState bundle?))
rate-expr : (and/c real? positive?)
limit-expr : (and/c integer? positive?)
```

tells DrRacket to apply *tick-expr* as above; the clock ticks every *rate-expr* seconds. The universe stops when the clock has ticked more than *limit-expr* times.

Changed in version 1.1 of package `htdp-lib`: allow universe handlers to return a plain universe state

- ```
(on-disconnect dis-expr)

dis-expr : (-> UniverseState iworld? (or/c UniverseState bundle?))
```

tells DrRacket to invoke *dis-expr* every time a participating world drops its connection to the server. The first argument is the current state of the universe server, while the second argument is the (representation of the) world that got disconnected. The resulting bundle usually includes this second argument in the third field, telling DrRacket not to wait for messages from this world anymore.

Changed in version 1.1 of package `htdp-lib`: allow universe handlers to return a plain universe state

- ```
(port port-expr)

port-expr : natural-number/c
```

specifies port on which a universe wishes to receive and send messages. A port number is an integer between 0 and 65536.

- ```
(to-string render-expr)

render-expr : (-> UniverseState string?)
```

tells DrRacket to render the state of the universe after each event and to display this string in the universe console.

- `(check-with universe?-expr)`  
`universe?-expr : (-> Any boolean?)`

ensure that what the event handlers produce is really an element of UniverseState.

- `(state expr)`

if not #f, DrRacket opens a separate window that shows the current state and the messages received from and sent to the registered worlds. This is mostly useful for debugging server programs.

### Exploring a Universe

In order to explore the workings of a universe, it is necessary to launch a server and several world programs on one and the same computer. We recommend launching one server out of one DrRacket tab and as many worlds as necessary out of a second tab. For the latter, the teachpack provides a special form.

```
(launch-many-worlds expression ...)
```

evaluates all sub-expressions in parallel. Typically each sub-expression is an application of a function that evaluates a big-bang expression. When all worlds have stopped, the expression returns all final worlds in order.

Once you have designed a world program, add a function definition concerning big-bang to the end of the tab:

```
; String -> World
(define (main n)
 (big-bang ... (name n) ...))
```

Then in DrRacket's Interactions area, use `launch-many-worlds` to create several distinctively named worlds:

```
> (launch-many-worlds (main "matthew")
 (main "kathi")
 (main "h3"))

10
25
33
```

The three worlds can then interact via a server. When all of them have stopped, they produce the final states, here 10, 25, and 33.

For advanced programmers, the library also provides a programmatic interface for launching many worlds in parallel.

```
(launch-many-worlds/proc thunk-that-runs-a-world
 ...) → any ...
thunk-that-runs-a-world : (-> any/c)
```

invokes all given *thunk-that-runs-a-world* in parallel. Typically each argument is a function of no argument that evaluates a big-bang expression. When all worlds have stopped, the function expression returns all final worlds in order.

It is thus possible to decide at run time how many and which worlds to run in parallel:

```
> (apply launch-many-worlds/proc
 (build-list (random 10)
 (lambda (i)
 (lambda ()
 (main (number->string i)))))))
0
9
1
2
3
6
5
4
8
7
```

## 2.4.7 A First Sample Universe

This section uses a simple example to explain the design of a universe, especially its server and some participating worlds. The first subsection explains the example, the second introduces the general design plan for such universes. The remaining sections present the full-fledged solution.

The code assumes the "Intermediate with Lambda" language.

### Two Ball Tossing Worlds

Say we want to represent a universe that consists of a number of worlds and that gives each world a “turn” in a round-robin fashion. If a world is given its turn, it displays a ball that ascends from the bottom of a canvas to the top. It relinquishes its turn at that point and the server gives the next world a turn.

Here is an image that illustrates how this universe would work if two worlds participated:

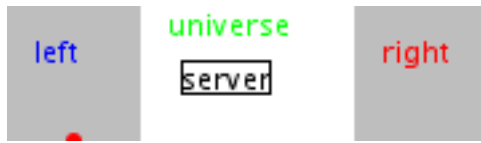

The two world programs could be located on two distinct computers or on just one. A server mediates between the two worlds, including the initial start-up.

### Hints on Designing Universes

The first step in designing a universe is to understand the coordination of the worlds from a global perspective. To some extent, it is all about knowledge and the distribution of knowledge throughout a system. We know that the universe doesn't exist until the server starts and the worlds are joining. Because of the nature of computers and networks, however, we may assume little else. Our network connections ensure that if some world or the server sends two messages to the *same* place in some order, they arrive in the same order (if they arrive at all). In contrast, if two distinct world programs send one message each, the network does not guarantee the order of arrival at the server; similarly, if the server is asked to send some messages to several distinct world programs, they may arrive at those worlds in the order sent or in the some other order. In the same vein, it is impossible to ensure that one world joins before another. Worst, when someone removes the connection (cable, wireless) between a computer that runs a world program and the rest of the network or if some network cable is cut, messages don't go anywhere. Due to this vagaries, it is therefore the designer's task to establish a protocol that enforces a certain order onto a universe and this activity is called *protocol design*.

From the perspective of the universe, the design of a protocol is about the design of data representations for tracking universe information in the server and the participating worlds and the design of a data representation for messages. As for the latter, we know that they must be S-expressions, but usually world programs don't send all kinds of S-expressions. The data definitions for messages must therefore select a subset of suitable S-expressions. As for the state of the server and the worlds, they must reflect how they currently relate to the universe. Later, when we design their "local" behavior, we may add more components to their state space.

In summary, the first step of a protocol design is to introduce:

- a data definition for the information about the universe that the server tracks, call it UniverseState;
- a data definition for the world(s) about their current relationship to the universe;
- data definitions for the messages that are sent from the server to the worlds and vice versa. Let's call them *S2W* for messages from the server to the worlds and *W2S* for the other direction; in the most general case you may need one pair per world.

If all the worlds exhibit the same behavior over time, a single data definition suffices for step

2. If they play different roles, we may need one data definition per world.

Of course, as you define these collections of data always keep in mind what the pieces of data mean, what they represent from the universe's perspective.

The second step of a protocol design is to figure out which major events—the addition of a world to the universe, the arrival of a message at the server or at a world—to deal with and what they imply for the exchange of messages. Conversely, when a server sends a message to a world, this may have implications for both the state of the server and the state of the world. A good tool for writing down these agreements is an interaction diagram.

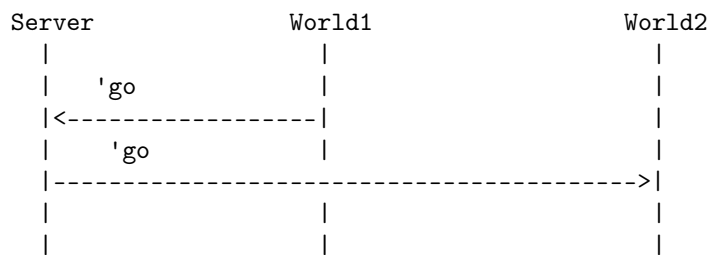

Each vertical line is the life line of a world program or the server. Each horizontal arrow denotes a message sent from one universe participant to another.

The design of the protocol, especially the data definitions, have direct implications for the design of event handling functions. For example, in the server we may wish to deal with two kinds of events: the joining of a new world and the receipt of a message from one of the worlds. This translates into the design of two functions with the following headers,

```
; Bundle is
; (make-bundle UniverseState [Listof mail?] [Listof iworld?])

; UniverseState iworld? -> Bundle
; next list of worlds when world iw is joining
; the universe in state s
(define (add-world s iw) ...)

; UniverseState iworld? W2U -> Bundle
; next list of worlds when world iw is sending message m to
; the universe in state s
(define (process s iw m) ...)
```

Finally, we must also decide how the messages affect the states of the worlds; which of their callback may send messages and when; and what to do with the messages a world receives. Because this step is difficult to explain in the abstract, we move on to the protocol design for the universe of ball worlds.

## Designing the Ball Universe

Running the ball universe has a simple overall goal: to ensure that at any point in time, one world is active and all others are passive. The active world displays a moving ball, and the passive worlds should display something, anything that indicates that it is some other world's turn.

As for the server's state, it must obviously keep track of all worlds that joined the universe, and it must know which one is active and which ones are passive. Of course, initially the universe is empty, i.e., there are no worlds and, at that point, the server has nothing to track.

While there are many different useful ways of representing such a universe, we just use the list of *iworl*ds that is handed to each handler and that handlers return via their bundles. The `UniverseState` itself is useless for this trivial example. We interpret non-empty lists as those where the first *iworl*d is active and the remainder are the passive *iworl*ds. As for the two possible events,

- it is natural to add new *iworl*ds to the end of the list; and
- it is natural to move an active *iworl*d that relinquishes its turn to the end of the list, too.

The server should send messages to the first *iworl*d of its list as long as it wishes this *iworl*d to remain active. In turn, it should expect to receive messages only from this one active *iworl*d and no other *iworl*d. The content of these two messages is nearly irrelevant because a message from the server to an *iworl*d means that it is the *iworl*d's turn and a message from the *iworl*d to the server means that the turn is over. Just so that we don't confuse ourselves, we use two distinct symbols for these two messages:

- A `GoMessage` is `'it-is-your-turn`.
- A `StopMessage` is `'done`.

From the universe's perspective, each world is in one of two states:

- A passive world is *resting*. We use `'resting` for this state.
- An active world is not resting. We delay choosing a representation for this part of a world's state until we design its "local" behavior.

It is also clear that an active world may receive additional messages, which it may ignore. When it is done with its turn, it will send a message.

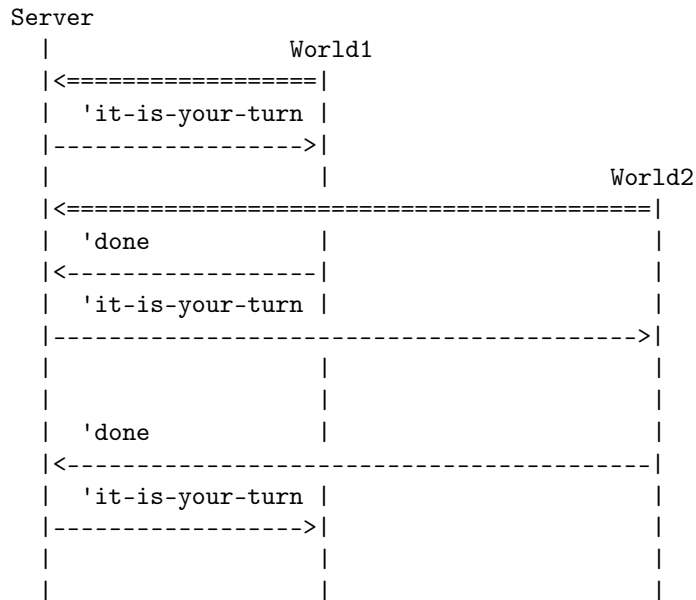

Here the double-lines (horizontal) denote the registration step, the others are message exchanges. The diagram thus shows how the server decides to make the first registered world the active one and to enlist all others as they join.

### Designing the Ball Server

The preceding subsection dictates that our server program starts like this:

```
(require 2htdp/universe)

; UniverseState is [Listof iworld?]
; StopMessage is 'done.
; GoMessage is 'it-is-your-turn.
```

The design of a protocol has immediate implications for the design of the event handling functions of the server. Here we wish to deal with two events: the appearance of a new world and the receipt of a message. Based on our data definitions and based on the general contracts of the event handling functions spelled out in this documentation, we get two functions for our wish list:

```
; Result is
; (make-bundle [Listof iworld?]
; (list (make-mail iworld? GoMessage))
; '())
; [Listof iworld?] iworld? -> Result
```

```

; add world iw to the universe, when server is in state u
(define (add-world u iw) ...)

; [Listof iworld?] iworld? StopMessage -> Result
; world iw sent message m when server is in state u
(define (switch u iw m) ...)

```

Although we could have re-used the generic contracts from this documentation, we also know from our protocol that our server sends a message to exactly one world. Note how these contracts are just refinements of the generic ones. (A type-oriented programmer would say that the contracts here are subtypes of the generic ones.)

The second step of the design recipe calls for functional examples:

```

; an obvious example for adding a world:
(check-expect
 (add-world '() iworld1)
 (make-bundle (list iworld1)
 (list (make-mail iworld1 'it-is-your-turn))
 '()))

; an example for receiving a message from the active world:
(check-expect
 (switch (list iworld1 iworld2) iworld1 'done)
 (make-bundle (list iworld2 iworld1)
 (list (make-mail iworld2 'it-is-your-turn))
 '()))

```

Note that our protocol analysis dictates this behavior for the two functions. Also note how we use `world1`, `world2`, and `world3` because the teachpack applies these event handlers to real worlds.

**Exercise** Create additional examples for the two functions based on our protocol.

The protocol tells us that *add-world* just adds the given *world* structure—recall that this a data representation of the actual world program—to the given list of worlds. It then sends a message to the first world on this list to get things going:

```

(define (add-world univ wrld)
 (local ((define univ* (append univ (list wrld))))
 (make-bundle univ*
 (list (make-mail (first univ*) 'it-is-your-turn))
 '()))))

```

Because *univ\** contains at least *wrld*, it is acceptable to create a mail to `(first univ*)`. Of

course, this same reasoning also implies that if *univ* isn't empty, its first element is an active world and is about to receive a second `'it-is-your-turn` message.

Similarly, the protocol says that when *switch* is invoked because a world program sends a message, the data representation of the corresponding world is moved to the end of the list and the next world on the (resulting) list is sent a message:

```
(define (switch univ wrld m)
 (local ((define univ* (append (rest univ) (list (first univ))))
 (make-bundle univ*
 (list (make-mail (first univ*) 'it-is-your-turn)
 '())))))
```

As before, appending the first world to the end of the list guarantees that there is at least this one world on this list. It is therefore acceptable to create a mail for this world.

Start the server now.

```
(universe '() (on-new add-world) (on-msg switch))
```

**Exercise** The function definition simply assumes that *wrld* is `iworld=?` to `(first univ)` and that the received message *m* is `'done`. Modify the function definition so that it checks these assumptions and raises an error signal if either of them is wrong. Start with functional examples. If stuck, re-read the section on checked functions from HtDP. (Note: in a universe it is quite possible that a program registers with a server but fails to stick to the agreed-upon protocol. How to deal with such situations properly depends on the context. For now, stop the universe at this point by returning an empty list of worlds. Consider alternative solutions, too.)

**Exercise** An alternative state representation would equate `UniverseState` with *world* structures, keeping track of the active world. The list of world in the server would track the passive worlds only. Design appropriate `add-world` and `switch` functions.

## Designing the Ball World

The final step is to design the ball world. Recall that each world is in one of two possible states: active or passive. The second kind of world moves a ball upwards, decreasing the ball's *y* coordinate; the first kind of world displays something that says it's someone else's turn. Assuming the ball always moves along a vertical line and that the vertical line is fixed, the state of the world is an enumeration of two cases:

```
(require 2htdp/universe)

; WorldState is one of:
; - Number % representing the y coordinate
; - 'resting
```

```
(define WORLD0 'resting)

; A WorldResult is one of:
; - WorldState
; - (make-package WorldState StopMessage)
```

The definition says that initially a world is passive.

The communication protocol and the refined data definition of `WorldState` imply a number of contract and purpose statements:

```
; WorldState GoMessage -> WorldResult
; make sure the ball is moving
(define (receive w n) ...)

; WorldState -> WorldResult
; move this ball upwards for each clock tick
; or stay 'resting
(define (move w) ...)

; WorldState -> Image
; render the world as an image
(define (render w) ...)
```

Let's design one function at a time, starting with *receive*. Since the protocol doesn't spell out what *receive* is to compute, let's create a good set of functional examples, exploiting the structure of the data organization of `WorldState`:

```
(check-expect (receive 'resting 'it-is-your-turn) HEIGHT)
(check-expect (receive (- HEIGHT 1) 'it-is-your-turn) ...)
```

Since there are two kinds of states, we make up at least two kinds of examples: one for a `'resting` state and another one for a numeric state. The dots in the result part of the second unit test reveal the first ambiguity; specifically it isn't clear what the result should be when an active world receives another message to activate itself. The second ambiguity shows up when we study additional examples, which are suggested by our approach to designing functions on numeric intervals (HtDP, section 3). That is we should consider the following three inputs to *receive*:

- `HEIGHT` when the ball is at the bottom of the image;
- `(- HEIGHT 1)` when the ball is properly inside the image; and
- `0` when the ball has hit the top of the image.

In the third case the function could produce three distinct results: 0, 'resting, or (make-package 'resting 'done). The first leaves things alone; the second turns the active world into a resting one; the third does so, too, and tells the universe about this switch.

We choose to design *receive* so that it ignores the message and returns the current state of an active world. This ensures that the ball moves in a continuous fashion and that the world remains active.

**Exercise** One alternative design is to move the ball back to the bottom of the image every time 'it-is-your-turn is received. Design this function, too.

```
(define (receive w m)
 (cond
 [(symbol? w) HEIGHT] ; meaning: (symbol=? w 'resting)
 [else w]))
```

Our second function to design is *move*, the function that computes the ball movement. We have the contract and the second step in the design recipe calls for examples:

```
; WorldState -> WorldState or (make-package 'resting 'done)
; move the ball if it is flying

(check-expect (move 'resting) 'resting)
(check-expect (move HEIGHT) (- HEIGHT 1))
(check-expect (move (- HEIGHT 1)) (- HEIGHT 2))
(check-expect (move 0) (make-package 'resting 'done))

(define (move x) ...)
```

Following HtDP again, the examples cover four typical situations: 'resting, two end points of the specified numeric interval, and one interior point. They tell us that *move* leaves a passive world alone and that it otherwise moves the ball until the y coordinate becomes 0. In the latter case, the result is a package that renders the world passive and tells the server about it.

Turning these thoughts into a complete definition is straightforward now:

```
(define (move x)
 (cond
 [(symbol? x) x]
 [(number? x) (if (<= x 0)
 (make-package 'resting 'done)
 (sub1 x))]))
```

**Exercise** what could happen if we had designed *receive* so that it produces 'resting when the state of the world is 0? Use your answer to explain why you think it is better to leave this kind of state change to the tick event handler instead of the message receipt handler?

Finally, here is the third function, which renders the state as an image:

```
; String -> (WorldState -> Image)
; render the state of the world as an image

(check-expect
 ((draw "Carl") 100)
 (overlay/xy (overlay/xy MT 50 100 BALL)
 5 85
 (text "Carl" 11 "black")))

(define (draw name)
 (lambda (w)
 (overlay/xy
 (cond
 [(symbol? w) (underlay/xy MT 10 10 (text "resting" 11 "red"))]
 [(number? w) (underlay/xy MT 50 w BALL)])
 5 85
 (text name 11 'black))))
```

By doing so, we can use the same program to create many different worlds that register with a server on your computer:

```
; String -> WorldState
; create and hook up a world with the LOCALHOST server
(define (create-world a-name)
 (big-bang WORLD0
 (on-receive receive)
 (to-draw (draw a-name))
 (on-tick move)
 (name a-name)
 (register LOCALHOST)))
```

Now you can use `(create-world 'carl)` and `(create-world 'sam)`, respectively, to run two different worlds, after launching a server first. You may wish to use `launch-many-worlds` here.

**Exercise** Design a function that takes care of a world to which the universe has lost its connection. Is *Result* the proper contract for the result of this function?

## 2.5 Web IO: "web-io.rkt"

```
(require 2htdp/web-io) package: htdp-lib
```

The teachpack provides a single function:

```
(show-in-browser x) → string?
x : xexpr?
```

Translates the given X-expression into a String. It also has the **effect** of opening an external browser and displaying the X-expression rendered as XHTML.

### Example

```
(show-in-browser '(html (body (b "hello world"))))
```

Added in version 1.0 of package `htdp-lib`.

## 2.6 iTunes: "itunes.rkt"

```
(require 2htdp/itunes) package: htdp-lib
```

The `itunes.rkt` teachpack implements and provides the functionality for reading the collection of tracks exported from iTunes.

In iTunes, select Library from the File menu and then choose Export Library. Doing so exports a description of your iTunes collection as a file in XML format.

### 2.6.1 Data Definitions

```
(struct track (name artist album time track# added play# played)
 #:extra-constructor-name make-track)
name : string?
artist : string?
album : string?
time : natural-number/c
track# : natural-number/c
added : date?
play# : natural-number/c
played : date?
```

is one representations for the music tracks in an iTunes collection.

An instance records that the track has title `name`, is produced by `artist`, belongs to `album`, plays for `time` milliseconds, is positioned at `track#`, was added at date `added`, has been played `play#` times, and was last played at `played` date.

```
(struct date (year month day hour minute second)
```

```

#:extra-constructor-name make-date)
year : natural-number/c
month : natural-number/c
day : natural-number/c
hour : natural-number/c
minute : natural-number/c
second : natural-number/c

```

is a representations of dates in an iTunes collection.

An instance records six pieces of information: the date's `year`, `month` (between 1 and 12 inclusive), `day` (between 1 and 31), `hour` (between 0 and 23), `minute` (between 0 and 59), and `second` (between 0 and 59).

In this context, we introduce the following data definitions:

```

; Track is a track?
; Date is date?

; LTracks is one of:
; - '()
; - (cons Track LTracks)

; LLists is one of:
; - '()
; - (cons LAssoc LLists)

; LAssoc is one of:
; - '()
; - (cons Association LAssoc)

; Association is (cons string? (cons BSDN '()))

; BSDN satisfies either string?, integer?, real?, Date, or
boolean?.

```

## 2.6.2 Exported Functions

```

(read-itunes-as-lists file-name) → LLists
 file-name : string?

```

creates a list-of-lists representation for all tracks in `file-name`, an XML export from an iTunes library.

**Effect** reads an XML document from `file-name`

Example:

```
(read-itunes-as-lists "Library.xml")
```

```
(read-itunes-as-tracks file-name) → LTracks
file-name : string?
```

creates a list-of-tracks representation for all tracks in *file-name*, an XML export from an iTunes library.

**Effect** reads an XML document from *file-name*

Example:

```
(read-itunes-as-tracks "Library.xml")
```

```
(create-track name
 artist
 album
 time
 track#
 added
 play#
 played) → (or/c track? false?)
name : string?
artist : string?
album : string?
time : natural-number/c
track# : natural-number/c
added : date?
play# : natural-number/c
played : date?
```

creates a track representation if the inputs live up to their predicates. Otherwise it produces `#false`.

**Note** This is a *checked* constructor.

```
> (create-track "one"
 "two"
 "three"
 4
 5
 (create-date 1 2 3 4 5 6)
 7
```

```

 (create-date 1 2 3 4 5 6))
(track "one" "two" "three" 4 5 (date 1 2 3 4 5 6) 7 (date 1 2 3 4
5 6))
> (create-track "one" "two" "three" 4 5 "a date" 7 "another date")
#f

```

```

(create-date year month day hour minute second)
→ (or/c date? false?)
year : natural-number/c
month : natural-number/c
day : natural-number/c
hour : natural-number/c
minute : natural-number/c
second : natural-number/c

```

creates a date representation if the inputs live up to their predicates. Otherwise it produces `#false`.

**Note** This is a *checked* constructor.

```

> (create-date 1 2 3 4 5 6)
(date 1 2 3 4 5 6)
> (create-date 1 2 3 "four" 5 6)
#f

```

In addition to the above, the teachpack exports the predicates for Track and Date plus all selectors:

```

track?
track-name
track-artist
track-album
track-time
track-track#
track-added
track-play#
track-played

date?
date-year
date-month
date-day
date-hour
date-minute
date-second

```

## 2.7 Abstraction: "abstraction.rkt"

```
(require 2htdp/abstraction) package: htdp-lib
```

The `abstract.rkt` teachpack provides some additional abstraction facilities: comprehensions and loops, matching, and algebraic data types. Most of these are restricted versions of full-featured constructs in other members of the Racket family so that students of HtDP/2e don't stumble across syntactic oddities.

HtDP/2e introduces loops and matching in an intermezzo, with the sole purpose of acknowledging the existence of powerful linguistic mechanisms.

Algebraic data types are provided for those who think teaching the features of functional programming is more important than teaching universally applicable ideas of program design.

Added in version 1.1 of package `htdp-lib`.

### 2.7.1 Loops and Comprehensions

```
(for/list (comprehension-clause comprehension-clause ...) body-expr)
comprehension-clause = (name clause-expr)
```

evaluates `body-expr` for the **parallel** sequences of values determined by the `comprehension-clauses`.

Each `comprehension-clause` binds its `name` in `body-expr`.

The `for/list` expression evaluates all `clause-expr` to generate sequences of values. If a `clause-expr` evaluates to a

- list, its items make up the sequence values;
- natural number `n`, the sequence of values consists of the numbers `0, 1, ..., (- n 1)`;
- string, its one-character strings are the sequence items.

For sequences generated by `in-range` and `in-naturals`, see below.

Finally, `for/list` evaluates `body-expr` with `name` ... successively bound to the values of the sequences determined by `clause-expr` ...

```
> (for/list ((i 10))
```

```

 i)
'(0 1 2 3 4 5 6 7 8 9)
> (for/list ((i 2) (j '(a b)))
 (list i j))
'((0 a) (1 b))
> (for/list ((c "abc"))
 c)
'("a" "b" "c")

```

The evaluation stops when the shortest sequence is exhausted.

```

> (for/list ((i 2) (j '(a b c d e)))
 (list i j))
'((0 a) (1 b))

```

▮ `(for*/list (comprehension-clause comprehension-clause ...) body-expr)`

evaluates *body-expr* for the **nested** sequences of values determined by the *comprehension-clauses*.

Each *comprehension-clause* binds its name in the expressions of the following *comprehension-clauses* as well as *body-expr*.

```

> (for*/list ((i 2) (j '(a b)))
 (list i j))
'((0 a) (0 b) (1 a) (1 b))
> (for*/list ((i 5) (j i))
 (list i j))
'((1 0) (2 0) (2 1) (3 0) (3 1) (3 2) (4 0) (4 1) (4 2) (4 3))

```

With nesting, the evaluation does **not** stop when the shortest sequence is exhausted because *comprehension-clauses* are evaluated in order:

```

> (for*/list ((i 2) (j '(a b c d e)))
 (list i j))
'((0 a) (0 b) (0 c) (0 d) (0 e) (1 a) (1 b) (1 c) (1 d) (1 e))

```

▮ `(for/or (comprehension-clause comprehension-clause ...) body-expr)`

iterates over the sequences generated by the *comprehension-clauses* like `for/list`. It produces the first non-`#false` value, if any, and `#false` otherwise.

```

> (for/or ([c "abcd"])
 (if (string=? "x" c) c #false))
#f

```

```
> (for/or ([c (list #false 1 #false 2)])
 c)
1
```

|(for\*/or (*comprehension-clause comprehension-clause ...*) *body-expr*)

iterates over the sequences generated by the *comprehension-clauses* like for\*/list. It produces the first non-*#false* value, if any, and *#false* otherwise.

```
> (for*/or ([i 2][j i])
 (if (> j i) (list i j) #false))
#f
```

|(for/and (*comprehension-clause comprehension-clause ...*) *body-expr*)

iterates over the sequences generated by the *comprehension-clauses* like for/list. If any evaluation of *body-expr* produces *#false*, the loop stops and returns *#false*, too; otherwise, the loop produces the result of the last evaluation of *body-expr*.

```
> (for/and ([c '(1 2 3)])
 (if (> c 4) c #false))
#f
> (for/and ([c '(1 2 3)])
 (if (< c 4) c #false))
3
```

|(for\*/and (*comprehension-clause comprehension-clause ...*) *body-expr*)

iterates over the sequences generated by the *comprehension-clauses* like for\*/list. If any evaluation of *body-expr* produces *#false*, the loop stops and returns *#false*, too; otherwise, the loop produces the result of the last evaluation of *body-expr*.

```
> (for*/and ([i 2][j i])
 (if (< j i) (list i j) #false))
'(1 0)
```

|(for/sum (*comprehension-clause comprehension-clause ...*) *body-expr*)

iterates over the sequences generated by the *comprehension-clauses* like for/list. It adds up the numbers that *body-expr* evaluates to.

```
> (for/sum ([i 2][j 8])
 (max i j))
1
```

```
(for*/sum (comprehension-clause comprehension-clause ...) body-expr)
```

iterates over the sequences generated by the *comprehension-clauses* like for\*/list. It adds up the numbers that *body-expr* evaluates to.

```
> (for*/sum ([i 2] [j i])
 (min i j))
0
```

```
(for/product (comprehension-clause comprehension-clause ...) body-expr)
```

iterates over the sequences generated by the *comprehension-clauses* like for/list. It multiplies the numbers that *body-expr* evaluates to.

```
> (for/product ([i 2] [j 3])
 (+ i j 1))
3
```

```
(for*/product (comprehension-clause comprehension-clause ...) body-expr)
```

iterates over the sequences generated by the *comprehension-clauses* like for\*/list. It multiplies the numbers that *body-expr* evaluates to.

```
> (for*/product ([i 2] [j i])
 (+ i j 1))
2
```

```
(for/string (comprehension-clause comprehension-clause ...) body-expr)
```

iterates over the sequences generated by the *comprehension-clauses* like for/list. It collects the one-character strings that *body-expr* evaluates to with *implode*.

```
> (for/string ([i "abc"])
 (int->string (+ (string->int i) 1)))
"bcd"
```

```
(for*/string (comprehension-clause comprehension-clause ...) body-expr)
```

iterates over the sequences generated by the *comprehension-clauses* like for\*/list. It collects the one-character strings that *body-expr* evaluates to with *implode*.

```
> (for*/string ([i "ab"][j (- (string->int i) 90)])
 (int->string (+ (string->int i) j)))
"abcdefghijklmnopghi"
```

```
(in-range start end step) → sequence?
 start : natural-number/c
 end : natural-number/c
 step : natural-number/c
(in-range end) → sequence?
 end : natural-number/c
```

generates a **finite** sequence of natural numbers.

If *start*, *end*, and *step* are provided, the sequence consists of *start*, (*+ start step*), (*+ start step step*), ... until the sum is greater than or equal to *end*.

```
> (for/list ([i (in-range 1 10 3)]) i)
'(1 4 7)
```

If only *end* is provided, *start* defaults to 0 and *step* to 1:

```
> (for/list ([i (in-range 3)])
 i)
'(0 1 2)
> (for/list ([i (in-range 0 3 1)])
 i)
'(0 1 2)
```

```
(in-naturals start) → sequence?
 start : natural-number/c
```

generates an **infinite** sequence of natural numbers, starting with *start*.

```
> (define (enumerate a-list)
 (for/list ([x a-list][i (in-naturals 1)])
 (list i x)))
> (enumerate '(Maxwell Einstein Planck Heisenberg Feynman))
'((1 Maxwell) (2 Einstein) (3 Planck) (4 Heisenberg) (5 Feynman))
> (enumerate '("Pinot noir" "Pinot gris" "Pinot blanc"))
'((1 "Pinot noir") (2 "Pinot gris") (3 "Pinot blanc"))
```

## 2.7.2 Pattern Matching

```
(match case-expr (pattern body-expr) ...)

pattern = name
 | literal-constant
 | (cons pattern pattern)
 | (list pattern ...)
 | (name pattern ...)
 | (? name)
```

dispatches like a `cond`, matching the result of `case-expr` sequentially against all `patterns`. The first successful match triggers the evaluation of the matching `body-expr`, whose value is the result of the entire match expression.

The literal constants commonly used are numbers, strings, symbols, and `'()`.

Each pattern that contains `names` binds these names in the corresponding `body-expr`.

Matching a value with a pattern proceeds according to the following rules. If the pattern is a

- `name`, it matches any value;
- `literal-constant`, it matches only the literal constant;
- `(cons pattern_1 pattern_2)`, it matches when the value is an instance of `cons`, and its first/rest fields match `pattern_1` and `pattern_2`, respectively;
- `(list pattern ...)`, it matches when the value is a `list`, and each element matches its corresponding `pattern`;
- `(name pattern ...)`, it matches when the value is an instance of the `name` structure type, and its field values match `pattern ...`;
- `(? name)`, it matches when `name` refers to a predicate function and the latter produces `#true` on the given value.

Furthermore, if the given pattern is `name` and the value is `V`, `name` stands for `V` during the evaluation of the corresponding `body-expr`.

The following match expression distinguishes `conses` with `'()` in the second position from all others:

```
> (define (last-item l)
 (match l
 [(cons lst '()) lst]
 [(cons fst rst) (last-item rst)]))
> (last-item '(a b c))
'c
```

The following match expression extracts the `title` of an HTML page in the nested `list` representation:

```
> (define (get-title page)
 (match page
 [(list 'html (list 'head (list 'title title)) body) title]
 [anything "Untitled"]))
> (get-title '(html (head (title "hello")) (body (p "world"))))
"hello"
> (get-title '(html (head) (body (p "world"))))
"Untitled"
```

With `?`, a match can use a predicate to distinguish arbitrary values:

```
> (define (is-it-odd-or-even l)
 (match l
 [(? even?) 'even]
 [(? odd?) 'odd]))
> (is-it-odd-or-even '1)
'odd
> (is-it-odd-or-even '2)
'even
```

A match expression can also deal with structure instances:

```
> (define-struct doll (layer))
> (define (inside a-doll)
 (match a-doll
 [(? symbol?) a-doll]
 [(doll below) (inside below)]))
> (inside (make-doll (make-doll 'wood)))
'wood
```

Note, however, that the pattern uses just `doll`, the name of the structure type, not `make-doll`, the constructor name.

### 2.7.3 Algebraic Data Types

```
(define-type type (variant (field predicate) ...) ...)
```

```

 type = name
 variant = name
 field = name
 predicate = name

```

defines structure types `variant` ... with fields `field` ..., respectively. In addition, it defines constructors that enforce that the field values satisfy the specified predicate. Finally, it introduces the name `type` as the name for the union of all `variant` structure types and `type?` as a predicate that determines whether a value belongs to this class of values.

Consider the following type definition:

```

(define-type BTree
 (leaf (info number?))
 (node (left BTree?) (right BTree?)))

```

It defines two structure types:

```

(define-struct leaf (info))
(define-struct node (left right))

```

The `make-leaf` constructor signals an error when applied to any other values but numbers, while `make-node` accepts only instances of `BTree`. Finally, `BTree?` is a predicate that recognizes such instances:

```

> (make-leaf 42)
(leaf 42)
> (make-node (make-leaf 42) (make-leaf 21))
(node (leaf 42) (leaf 21))
> (BTree? (make-node (make-leaf 42) (make-leaf 21)))
#t

```

And here is how a constructor fails when applied to the wrong kind of values:

```

> (make-leaf 'four)
make-leaf: contract violation
 expected: (or/c undefined? number?)
 given: 'four
 in: the 1st argument of
 (-> (or/c undefined? number?) leaf?)
 contract from: make-leaf
 blaming: use
 (assuming the contract is correct)
 at: program:2:0

```

```
(type-case type case-expr (variant (field ...) body-expr) ...)
```

dispatches like a `cond`, matching the result of `case-expr` sequentially against all `variants`. The first successful match triggers the evaluation of the matching `body-expr`, whose value is the result of the entire `type-case` expression.

A `type-case` expression also ensures that (1) the collection `variant` cases covers all variant structure type definitions in `type` and (2) that each `variant` clause specifies as many fields as the definition of `type` specifies.

Assume that the following definition is placed in the scope of the above type definition for `BTree`:

```
(define (depth t)
 (type-case BTree t
 [leaf (info) 0]
 [node (left right) (+ (max (depth left) (depth right)) 1)]))
```

This function definition uses a `type-case` for `BTree` and the latter consists of two clauses: one for `leafs` and one for `nodes`. The function computes the depth of the given tree.

```
> (depth (make-leaf 42))
0
> (depth (make-node (make-leaf 42) (make-leaf 21)))
1
```

## 2.8 Planet Cute Images

```
(require 2htdp/planetcute) package: htdp-lib
```

The `2htdp/planetcute` library contains the Planet Cute art by Daniel Cook (Lostgarden.com).

The images are designed to be overlaid with each other to build scenes for use in games. Here is an example image taken from the Planet Cute website.

```
; stack : non-empty-list-of-images -> image
; stacks 'imgs' on each other, separated by 40 pixels
(define (stack imgs)
 (cond
 [(empty? (rest imgs)) (first imgs)]
 [else (overlay/xy (first imgs)
 0 40
 (stack (rest imgs)))]))
```

```

> (beside/align
 "bottom"
 (stack (list wall-block-tall stone-block))
 (stack (list character-cat-girl
 stone-block stone-block
 stone-block stone-block))
 water-block
 (stack (list grass-block dirt-block))
 (stack (list grass-block dirt-block dirt-block)))

```

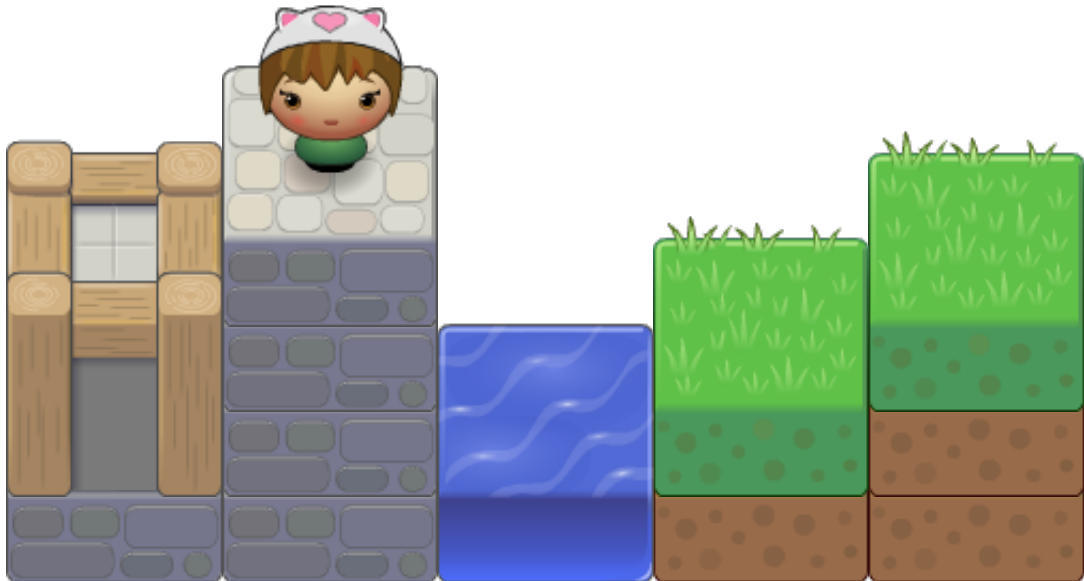

The Planet Cute images also include some shadows that can improve the look of your game; see the §2.8.6 “Shadows” section for an overview of how to use them.

### 2.8.1 Characters

| `character-boy` : `image?`



| character-cat-girl : image?



| character-horn-girl : image?



| character-pink-girl : image?



| character-princess-girl : image?



| enemy-bug : image?



| speech-bubble : image?



## 2.8.2 Blocks

`brown-block : image?`



`dirt-block : image?`



| grass-block : image?

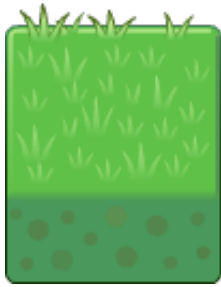

| plain-block : image?



| stone-block-tall : image?



| stone-block : image?



| wall-block-tall : image?



| wall-block : image?



| water-block : image?

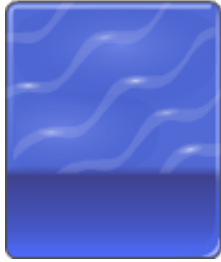

| wood-block : image?



### 2.8.3 Items

| chest-closed : image?

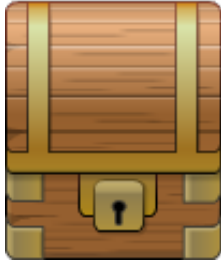

`chest-lid : image?`



`chest-open : image?`

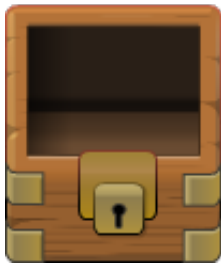

`gem-blue : image?`



| gem-green : image?



| gem-orange : image?



| heart : image?



| key : image?



| rock : image?



| selector : image?



| tree-short : image?



| tree-tall : image?



| tree-ugly : image?



|yellow-star : image?



#### 2.8.4 Ramps

|ramp-east : image?



ramp-north : image?



ramp-south : image?



ramp-west : image?



## 2.8.5 Buildings

`door-tall-closed` : image?



`door-tall-open` : image?

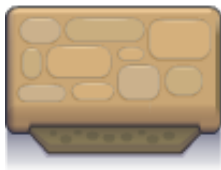

`roof-east` : image?

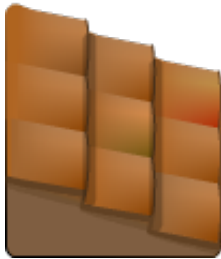

| roof-north-east : image?



| roof-north-west : image?



| roof-north : image?



| roof-south-east : image?

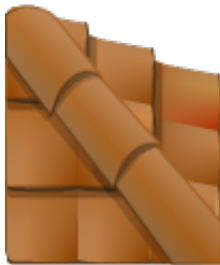

| roof-south-west : image?

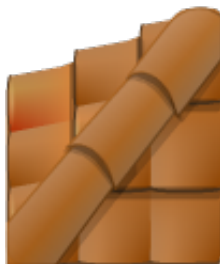

| roof-south : image?

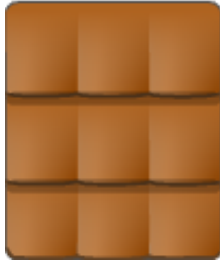

| roof-west : image?



| window-tall : image?



### **2.8.6 Shadows**

The shadow images are intended to be overlaid on the other blocks when they appear in certain configurations, as detailed here.

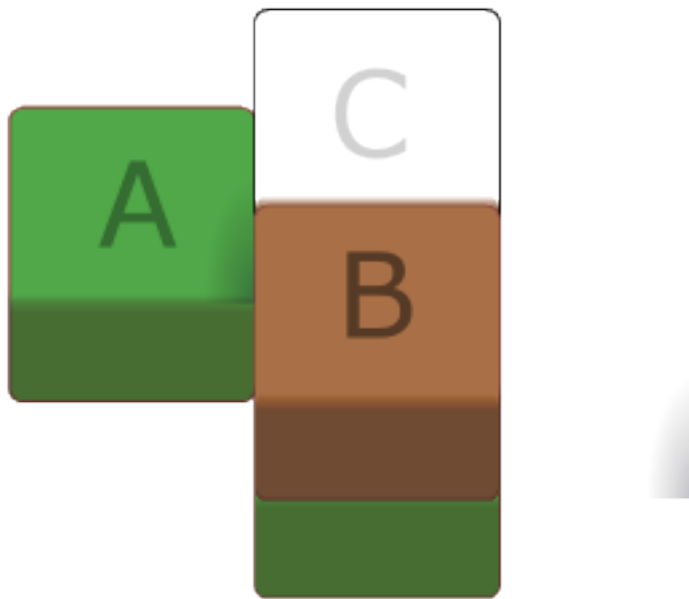

Place Shadow South East when tile B is located relative to tile as shown and there is not a tile at location C



Place Shadow East when tile B is located relative to tile as shown



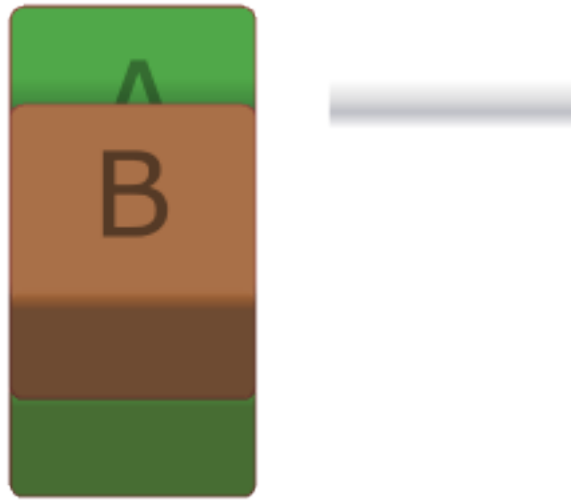

Place Shadow South when tile B is located relative to tile A as shown

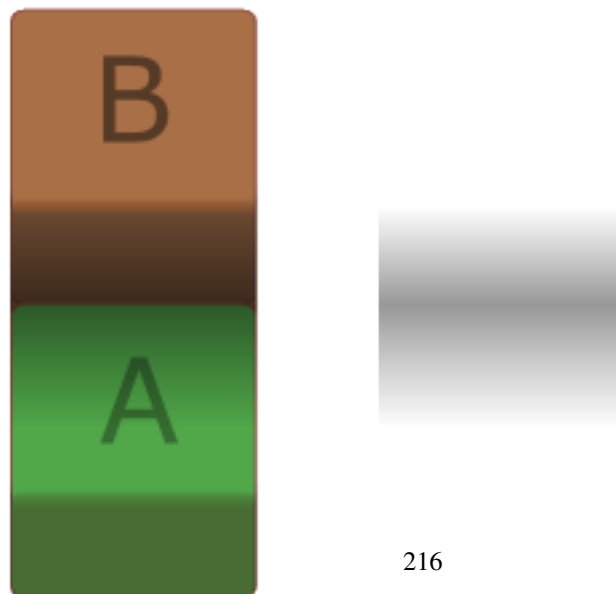

Place Shadow North when tile B is located relative to tile A as shown

Place Shadow South again when there is no tile in position C and tile B is the topmost tile in the stack.

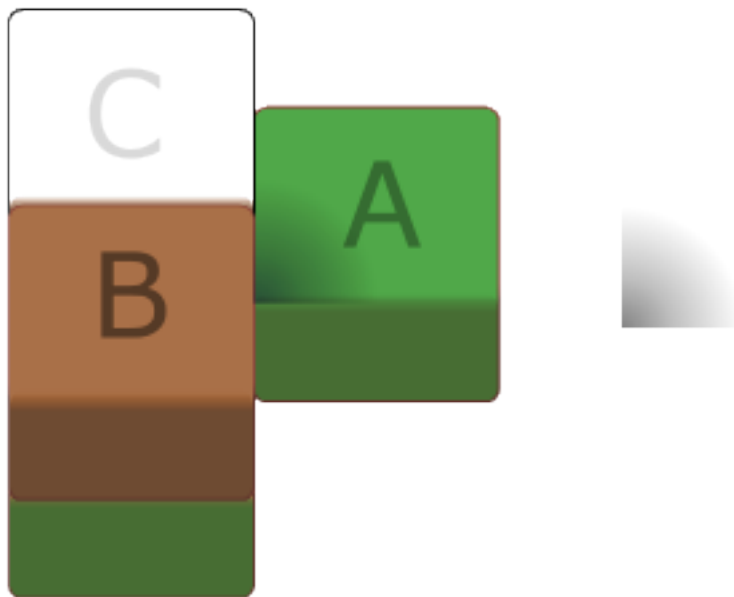

Place Shadow South West when tile B is located relative to tile as shown and there is not a tile at location C



Place Shadow West when tile B is located relative to tile as shown



shadow-east : image?



shadow-north-east : image?



shadow-north-west : image?

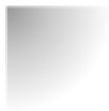

| shadow-north : image?



| shadow-side-west : image?



| shadow-south-east : image?



| shadow-south-west : image?



| shadow-south : image?

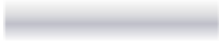

| shadow-west : image?



## 2.9 Porting World Programs to Universe

### 2.9.1 The World is Not Enough

With the June 2009 release, we started deprecating the world teachpack; instead we recommended the use of the universe teachpack. With the January 2010 release, we are also introducing a new image teachpack and, in support of this second teachpack, we have separated out the image functionality from the functionality for world programs.

In this document, we explain how to port programs that assume the old world teachpack into this new setting, one step at a time. Most importantly, programs must now import *two* teachpacks instead of one:

| World Style                     | Universe Style                                           |
|---------------------------------|----------------------------------------------------------|
| <pre>(require htdp/world)</pre> | <pre>(require 2htdp/universe) (require htdp/image)</pre> |

The table shows the old style on the left and the new style on the right. If your programs imported teachpacks via the drscheme teachpack menu, we recommend that you use the `require` form from now on; alternatively, you use the drscheme menu *twice* to import the functions from two teachpacks.

In the next section, we first explain how to port world programs so that they use the universe teachpack and the *old* image teachpack. In the section after that, we list suggestions for changing programs so that they no longer rely on the old image functionality but the new one.

In order to distinguish between the various pieces of functionality, we uniformly prefix old functionality with "htdp:" and new functionality with "2htdp:". There is no need to use these prefixes in your programs of course.

### 2.9.2 Porting World Programs

Here is the first program from the documentation for the world teachpack:

```
(require htdp/world)

; Number -> Scene
(define (create-UFO-scene height)
 (htdp:place-image UFO
 50 height
 (htdp:empty-scene 100 100)))
```

```

; Scene
(define UFO
 (htdp:overlay
 (htdp:circle 10 'solid 'red)
 (htdp:rectangle 40 4 'solid 'red)))

; -- run program run
(htdp:big-bang 100 100 (/1 28) 0)
(htdp:on-tick-event add1)
(htdp:on-redraw create-UFO-scene)

```

This program defines a function for placing a `UFO` into a 100 by 100 scene, where `UFO` is a defined image. The world program itself consists of three lines:

- the first one creates the 100 by 100 scene, specifies a rate of 28 images per second, and 0 as the initial world description;
- the second one says that for each clock tick, the world (a number) is increased by 1; and
- the last line tells drscheme to use `create-UFO-scene` as the function that renders the current world as a scene.

Let us now convert this program into the universe setting, step by step, starting with the require specification, which is converted as above:

| World Style                       | Universe Style                        |
|-----------------------------------|---------------------------------------|
| <code>(require htdp/world)</code> | <code>(require 2htdp/universe)</code> |
|                                   | <code>(require htdp/image)</code>     |

The function that renders the world as a scene remains the same:

| World Style                                    | Universe Style                                 |
|------------------------------------------------|------------------------------------------------|
| <code>; Number -&gt; Scene</code>              | <code>; Number -&gt; Scene</code>              |
| <code>(define (create-UFO-scene height)</code> | <code>(define (create-UFO-scene height)</code> |
| <code>(htdp:place-image</code>                 | <code>(htdp:place-image</code>                 |
| <code>UFO</code>                               | <code>UFO</code>                               |
| <code>50 height</code>                         | <code>50 height</code>                         |
| <code>(htdp:empty-scene 100 100)))</code>      | <code>(htdp:empty-scene 100 100)))</code>      |

For the image constant we switch from symbols to strings:

| World Style | Universe Style |
|-------------|----------------|
|-------------|----------------|

```

; Scene
(define UFO
 (htdp:overlay
 (htdp:circle
 10 'solid 'red)
 (htdp:rectangle
 40 4 'solid 'red)))

; Scene
(define UFO
 (htdp:overlay
 (htdp:circle
 10 "solid" "red")
 (htdp:rectangle
 40 4 "solid" "red")))

```

Strictly speaking, this isn't necessary, but we intend to replace symbols with strings whenever possible because strings are more common than symbols.

The most important change concerns the lines that launch the world program:

| World Style                                     | Universe Style                           |
|-------------------------------------------------|------------------------------------------|
| <code>(htdp:big-bang 100 100 (/ 1 28) 0)</code> | <code>(2htdp:big-bang</code>             |
| <code>(htdp:on-tick-event add1)</code>          | <code>0</code>                           |
| <code>(htdp:on-redraw create-UFO-scene)</code>  | <code>(on-tick add1)</code>              |
|                                                 | <code>(on-draw create-UFO-scene))</code> |

They are turned into a single expression that comes with as many clauses as there are lines in the old program. As you can see, the `big-bang` expression from the universe teachpack no longer requires the specification of the size of the scene or the rate at which the clock ticks (though it is possible to supply the clock rate if the default is not satisfactory). Furthermore, the names of the clauses are similar to the old names but shorter.

The other big change concerns key event handling and mouse event handling. The respective handlers no longer accept symbols and chars but strings only. Here is the first key event handler from the documentation of the world teachpack:

| World Style | Universe Style |
|-------------|----------------|
|-------------|----------------|

```

(define (change w a-key-event)
 (cond
 [(key=? a-key-event 'left)
 (world-go w -DELTA)]
 [(key=? a-key-event 'right)
 (world-go w +DELTA)]
 [(char? a-key-event)
 w]
 [(key=? a-key-event 'up)
 (world-go w -DELTA)]
 [(key=? a-key-event 'down)
 (world-go w +DELTA)]
 [else
 w])))

(define (change w a-key-event)
 (cond
 [(key=? a-key-event "left")
 (world-go w -DELTA)]
 [(key=? a-key-event "right")
 (world-go w +DELTA)]
 [(= (string-length a-key-event) 1)
 w]
 [(key=? a-key-event "up")
 (world-go w -DELTA)]
 [(key=? a-key-event "down")
 (world-go w +DELTA)]
 [else
 w])))

```

Note how the `char?` clause changed. Since all chars are now represented as strings containing one “letter”, the program on the right just checks the length of the string. Otherwise, we simply change all symbols into strings.

If you ever recorded your programs’ work via an animated gif, you can still do so. Instead of adding a fifth argument to `big-bang`, however, you will need to add a clause of the shape `(record? x)`.

Finally, the universe teachpack implements a richer functionality than the world teachpack.

### 2.9.3 Porting Image Programs

The universe library also comes with a new image library, `2htdp/image`. Using the old image library still works fine with `2htdp/universe`, but the new image library provides a number of improvements, including faster image comparison (especially useful in `check-expect` expressions), rotating images, scaling images, curves, a number of new polygon shapes, and more control over line drawing.

To use the new image library in isolation:

| World Style                       | Universe Style                     |
|-----------------------------------|------------------------------------|
| <code>(require htdp/image)</code> | <code>(require 2htdp/image)</code> |

and to use the new image library with the universe teachpack:

| World Style | Universe Style |
|-------------|----------------|
|             |                |

```
(require htdp/world) (require 2htdp/universe)
 (require 2htdp/image)
```

## Overlay vs Underlay

The `htdp:overlay` function places its first argument under its second (and subsequent) arguments and so in `2htdp/image`, we decided to call that function `2htdp:underlay`.

World Style

```
(htdp:overlay
 (htdp:rectangle
 10 20 "solid" "red")
 (htdp:rectangle
 20 10 "solid" "blue"))
```

Universe Style

```
(2htdp:underlay
 (2htdp:rectangle
 10 20 "solid" "red")
 (2htdp:rectangle
 20 10 "solid" "blue"))
```

## No more pinholes

The concept of pinholes from `htdp/image` has no correspondance in `2htdp/image` (we do expect to bring back pinholes in `2htdp/image` eventually, but they will not be as pervasive as they are in `htdp/image`).

Instead of a special position in the image that overlay operations are sensitive to, `2htdp/image` has a family of overlay operations, that overlay images based on their centers or their edges.

Since the default position of the pinhole is in the center for most images and the default for overlaying and underlaying images in `2htdp/image` is based on the center, simple examples (like the one above) behave the same in both libraries.

But, consider this expression that overlays two images on their upper-left corners, written using both libraries.

World Style

```
(htdp:overlay
 (htdp:put-pinhole
 (htdp:rectangle 10 20 "solid" "red")
 0 0)
 (htdp:put-pinhole
 (htdp:rectangle 20 10 "solid" "blue")
 0 0))
```

Universe Style

```
(2htdp:underlay/align
 "left"
 "top"
 (2htdp:rectangle
 10 20 "solid" "red")
 (2htdp:rectangle
 20 10 "solid" "blue"))
```

In the `2htdp/image` version, the programmer uses `2htdp:underlay/align` to specify where the images should be lined up, instead of using the pinhole.

## Outlines in different places

The outline style shapes are now shifted by one pixel for `2htdp/image` images as compared to `htdp/image`. This means that these two rectangles draw the same sets of pixels.

World Style

```
(htdp:rectangle
 11 11 "outline" "black")
```

Universe Style

```
(2htdp:rectangle
 10 10 "outline" "black")
```

See also §2.2.7 “The Nitty Gritty of Pixels, Pens, and Lines”.

## Star changed

The `2htdp:star` function is a completely different function from `htdp:star`. Both produce stars based, on polygons, but `2htdp:star` always produces a five-pointed star. See also `2htdp:star-polygon` for more general star shapes.